



RX-V4600

AV Receiver

OWNER'S MANUAL

IMPORTANT SAFETY INSTRUCTIONS

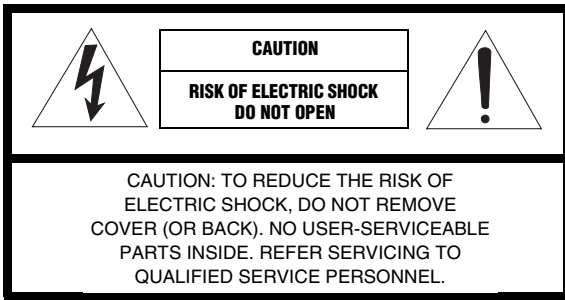

• Explanation of Graphical Symbols



The lightning flash with arrowhead symbol, within an equilateral triangle, is intended to alert you to the presence of uninsulated “dangerous voltage” within the product’s enclosure that may be of sufficient magnitude to constitute a risk of electric shock to persons.



The exclamation point within an equilateral triangle is intended to alert you to the presence of important operating and maintenance (servicing) instructions in the literature accompanying the appliance.

- 1 Read Instructions – All the safety and operating instructions should be read before the product is operated.
- 2 Retain Instructions – The safety and operating instructions should be retained for future reference.
- 3 Heed Warnings – All warnings on the product and in the operating instructions should be adhered to.
- 4 Follow Instructions – All operating and use instructions should be followed.
- 5 Cleaning – Unplug this product from the wall outlet before cleaning. Do not use liquid cleaners or aerosol cleaners.
- 6 Attachments – Do not use attachments not recommended by the product manufacturer as they may cause hazards.
- 7 Water and Moisture – Do not use this product near water – for example, near a bath tub, wash bowl, kitchen sink, or laundry tub; in a wet basement; or near a swimming pool; and the like.
- 8 Accessories – Do not place this product on an unstable cart, stand, tripod, bracket, or table. The product may fall, causing serious injury to a child or adult, and serious damage to the product. Use only with a cart, stand, tripod, bracket, or table recommended by the manufacturer, or sold with the product. Any mounting of the product should follow the manufacturer’s instructions, and should use a mounting accessory recommended by the manufacturer.
- 9 A product and cart combination should be moved with care. Quick stops, excessive force, and uneven surfaces may cause the product and cart combination to overturn.
- 10 Ventilation – Slots and openings in the cabinet are provided for ventilation and to ensure reliable operation of the product and to protect it from overheating, and these openings must not be blocked or covered. The openings should never be blocked by placing the product on a bed, sofa, rug, or other similar surface. This product should not be placed in a built-in installation such as a bookcase or rack unless proper ventilation is provided or the manufacturer’s instructions have been adhered to.
- 11 Power Sources – This product should be operated only from the type of power source indicated on the marking label. If you are not sure of the type of power supply to your home, consult your product dealer or local power company. For products intended to operate from battery power, or other sources, refer to the operating instructions.
- 12 Grounding or Polarization – This product may be equipped with a polarized alternating current line plug (a plug having one blade wider than the other). This plug will fit into the power outlet only one way. This is a safety feature. If you are unable to insert the plug fully into the outlet, try reversing the plug. If the plug should still fail to fit, contact your electrician to replace your obsolete outlet. Do not defeat the safety purpose of the polarized plug.
- 13 Power-Cord Protection – Power-supply cords should be routed so that they are not likely to be walked on or pinched by items placed upon or against them, paying particular attention to cords at plugs, convenience receptacles, and the point where they exit from the product.
- 14 Lightning – For added protection for this product during a lightning storm, or when it is left unattended and unused for long periods of time, unplug it from the wall outlet and disconnect the antenna or cable system. This will prevent damage to the product due to lightning and power-line surges.
- 15 Power Lines – An outside antenna system should not be located in the vicinity of overhead power lines or other electric light or power circuits, or where it can fall into such power lines or circuits. When installing an outside antenna system, extreme care should be taken to keep from touching such power lines or circuits as contact with them might be fatal.
- 16 Overloading – Do not overload wall outlets, extension cords, or integral convenience receptacles as this can result in a risk of fire or electric shock.
- 17 Object and Liquid Entry – Never push objects of any kind into this product through openings as they may touch dangerous voltage points or short-out parts that could result in a fire or electric shock. Never spill liquid of any kind on the product.
- 18 Servicing – Do not attempt to service this product yourself as opening or removing covers may expose you to dangerous voltage or other hazards. Refer all servicing to qualified service personnel.
- 19 Damage Requiring Service – Unplug this product from the wall outlet and refer servicing to qualified service personnel under the following conditions:
 - a) When the power-supply cord or plug is damaged,
 - b) If liquid has been spilled, or objects have fallen into the product,
 - c) If the product has been exposed to rain or water,



- d) If the product does not operate normally by following the operating instructions. Adjust only those controls that are covered by the operating instructions as an improper adjustment of other controls may result in damage and will often require extensive work by a qualified technician to restore the product to its normal operation,
 - e) If the product has been dropped or damaged in any way, and
 - f) When the product exhibits a distinct change in performance - this indicates a need for service.
- 20 Replacement Parts** – When replacement parts are required, be sure the service technician has used replacement parts specified by the manufacturer or have the same characteristics as the original part. Unauthorized substitutions may result in fire, electric shock, or other hazards.
- 21 Safety Check** – Upon completion of any service or repairs to this product, ask the service technician to perform safety checks to determine that the product is in proper operating condition.
- 22 Wall or Ceiling Mounting** – The unit should be mounted to a wall or ceiling only as recommended by the manufacturer.
- 23 Heat** – The product should be situated away from heat sources such as radiators, heat registers, stoves, or other products (including amplifiers) that produce heat.

- 24 Outdoor Antenna Grounding** – If an outside antenna or cable system is connected to the product, be sure the antenna or cable system is grounded so as to provide some protection against voltage surges and built-up static charges. Article 810 of the National Electrical Code, ANSI/NFPA 70, provides information with regard to proper grounding of the mast and supporting structure, grounding of the lead-in wire to an antenna discharge unit, size of grounding conductors, location of antenna discharge unit, connection to grounding electrodes, and requirements for the grounding electrode.

EXAMPLE OF ANTENNA GROUNDING

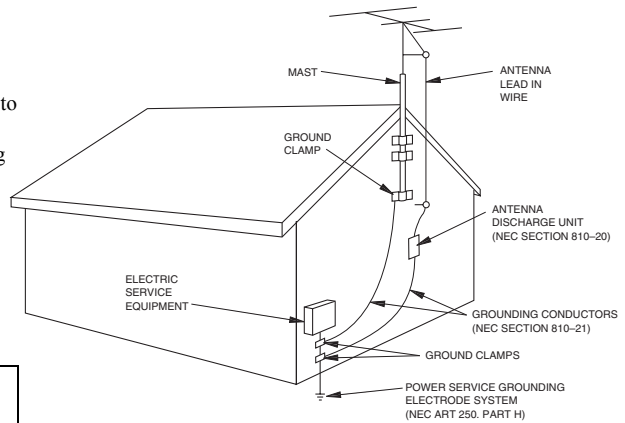

NEC – NATIONAL ELECTRICAL CODE

Note to CATV system installer:

This reminder is provided to call the CATV system installer’s attention to Article 820-40 of the NEC that provides guidelines for proper grounding and, in particular, specifies that the cable ground shall be connected to the grounding system of the building, as close to the point of cable entry as practical.

FCC INFORMATION (for US customers)

- 1 IMPORTANT NOTICE: DO NOT MODIFY THIS UNIT!**
This product, when installed as indicated in the instructions contained in this manual, meets FCC requirements. Modifications not expressly approved by Yamaha may void your authority, granted by the FCC, to use the product.
- 2 IMPORTANT:** When connecting this product to accessories and/or another product use only high quality shielded cables. Cable/s supplied with this product **MUST** be used. Follow all installation instructions. Failure to follow instructions could void your FCC authorization to use this product in the USA.
- 3 NOTE:** This product has been tested and found to comply with the requirements listed in FCC Regulations, Part 15 for Class “B” digital devices. Compliance with these requirements provides a reasonable level of assurance that your use of this product in a residential environment will not result in harmful interference with other electronic devices.
This equipment generates/uses radio frequencies and, if not installed and used according to the instructions found in the users manual, may cause interference harmful to the operation of other electronic devices.

Compliance with FCC regulations does not guarantee that interference will not occur in all installations. If this product is found to be the source of interference, which can be determined by turning the unit “OFF” and “ON”, please try to eliminate the problem by using one of the following measures:

- Relocate either this product or the device that is being affected by the interference.
- Utilize power outlets that are on different branch (circuit breaker or fuse) circuits or install AC line filter/s.
- In the case of radio or TV interference, relocate/reorient the antenna. If the antenna lead-in is 300 ohm ribbon lead, change the lead-in to coaxial type cable.

If these corrective measures do not produce satisfactory results, please contact the local retailer authorized to distribute this type of product. If you can not locate the appropriate retailer, please contact Yamaha Electronics Corp., U.S.A. 6660 Orangethorpe Ave, Buena Park, CA 90620.

The above statements apply **ONLY** to those products distributed by Yamaha Corporation of America or its subsidiaries.

CAUTION: READ THIS BEFORE OPERATING YOUR UNIT.

- 1 To assure the finest performance, please read this manual carefully. Keep it in a safe place for future reference.
- 2 Install this sound system in a well ventilated, cool, dry, clean place – away from direct sunlight, heat sources, vibration, dust, moisture, and/or cold. Allow ventilation space of at least 30 cm on the top, 20 cm on the left and right, and 20 cm on the back of this unit.
- 3 Locate this unit away from other electrical appliances, motors, or transformers to avoid humming sounds.
- 4 Do not expose this unit to sudden temperature changes from cold to hot, and do not locate this unit in an environment with high humidity (i.e. a room with a humidifier) to prevent condensation inside this unit, which may cause an electrical shock, fire, damage to this unit, and/or personal injury.
- 5 Avoid installing this unit where foreign objects may fall onto this unit and/or this unit may be exposed to liquid dripping or splashing. On the top of this unit, do not place:
 - Other components, as they may cause damage and/or discoloration on the surface of this unit.
 - Burning objects (i.e. candles), as they may cause fire, damage to this unit, and/or personal injury.
 - Containers with liquid in them, as they may fall and liquid may cause electrical shock to the user and/or damage to this unit.
- 6 Do not cover this unit with a newspaper, tablecloth, curtain, etc. in order not to obstruct heat radiation. If the temperature inside this unit rises, it may cause fire, damage to this unit, and/or personal injury.
- 7 Do not plug in this unit to a wall outlet until all connections are complete.
- 8 Do not operate this unit upside-down. It may overheat, possibly causing damage.
- 9 Do not use force on switches, knobs and/or cords.
- 10 When disconnecting the power cable from the wall outlet, grasp the plug; do not pull the cable.
- 11 Do not clean this unit with chemical solvents; this might damage the finish. Use a clean, dry cloth.
- 12 Only voltage specified on this unit must be used. Using this unit with a higher voltage than specified is dangerous and may cause fire, damage to this unit, and/or personal injury. YAMAHA will not be held responsible for any damage resulting from use of this unit with a voltage other than specified.
- 13 To prevent damage by lightning, disconnect the AC power cable and disconnect the antenna cable when there is an electrical storm.
- 14 Do not attempt to modify or fix this unit. Contact qualified YAMAHA service personnel when any service is needed. The cabinet should never be opened for any reasons.
- 15 When not planning to use this unit for long periods of time (i.e. vacation), disconnect the AC power plug from the wall outlet.
- 16 Be sure to read the “TROUBLESHOOTING” section on common operating errors before concluding that this unit is faulty.
- 17 Before moving this unit, press STANDBY/ON to set this unit in the standby mode, and disconnect the AC power plug from the wall outlet.
- 18 **VOLTAGE SELECTOR (Asia and General models only)**
The VOLTAGE SELECTOR on the rear panel of this unit must be set for your local main voltage BEFORE plugging into the AC main supply. Voltages are:
General modelAC 110/120/220/230–240 V, 50/60 Hz
Asia modelAC 220/230–240 V, 50/60 Hz

WARNING

TO REDUCE THE RISK OF FIRE OR ELECTRIC SHOCK, DO NOT EXPOSE THIS UNIT TO RAIN OR MOISTURE.

This unit is not disconnected from the AC power source as long as it is connected to the wall outlet, even if this unit itself is turned off. This state is called the standby mode. In this state, this unit is designed to consume a very small quantity of power.

FOR CANADIAN CUSTOMERS

To prevent electric shock, match wide blade of plug to wide slot and fully insert.
This Class B digital apparatus complies with Canadian ICES-003.

POUR LES CONSOMMATEURS CANADIENS

Pour éviter les chocs électriques, introduire la lame la plus large de la fiche dans la borne correspondante de la prise et pousser jusqu'au fond.
Cet appareil numérique de la classe B est conforme à la norme NMB-003 du Canada.

IMPORTANT

Please record the serial number of this unit in the space below.
MODEL:
Serial No.:
The serial number is located on the rear of the unit.
Retain this Owner's Manual in a safe place for future reference.

We Want You Listening For A Lifetime

YAMAHA and the Electronic Industries Association's Consumer Electronics Group want you to get the most out of your equipment by playing it at a safe level. One that lets the sound come through loud and clear without annoying blaring or distortion – and, most importantly, without affecting your sensitive hearing. Since hearing damage from loud sounds is often undetectable until it is too late, YAMAHA and the Electronic Industries Association's Consumer Electronics Group recommend you to avoid prolonged exposure from excessive volume levels.



CONTENTS

INTRODUCTION

FEATURES	2
GETTING STARTED	3
Supplied accessories	3
Installing batteries in the remote controls.....	4
CONTROLS AND FUNCTIONS	5
Front panel.....	5
Remote control.....	7
Zone 2/Zone 3 remote control	9
Using the remote controls	9
Front panel display	10
Rear panel	12

PREPARATION

SPEAKER SETUP	13
Speaker placement	13
Speaker connections	15
CONNECTIONS	18
Before connecting components.....	18
Connecting video components.....	19
Connecting audio components.....	22
Connecting the antennas.....	24
Connecting the power cable.....	25
Speaker impedance setting	26
Turning on the power.....	26
AUTO SETUP	27
Introduction.....	27
Optimizer microphone setup.....	27
Starting the setup	28
Confirming the results	30

BASIC OPERATION

PLAYBACK	33
Basic operations.....	33
Selecting sound field programs	34
Additional operations.....	35
Selecting audio input modes.....	40
TUNING	41
Automatic and manual tuning.....	41
Presetting stations	42
Selecting preset stations.....	44
Exchanging preset stations	44
Using HD Radio™	45
HD Radio™ tuning.....	45
Selecting HD Radio™ audio programs	46
Displaying HD Radio™ information	46
RECORDING	47

SOUND FIELD PROGRAMS

SOUND FIELD PROGRAM	
DESCRIPTIONS	48
For movie/video sources.....	48
For music sources	50

ADVANCED OPERATION

ADVANCED OPERATIONS	51
Using the sleep timer	51
SYSTEM OPTIONS	52
Changing parameter settings	54
Input Select	55
Manual Setup (Sound).....	58
Manual Setup (Basic)	61
Manual Setup (Option).....	66
System Memory.....	69
REMOTE CONTROL FEATURES	70
Control area	70
Setting remote control codes	71
Programming codes from other remote controls (Learn).....	73
Changing source names in the display window.....	75
Using the Macro feature	76
Clearing function sets	78
Clearing individual functions	79
Controlling each component.....	81
ZONE 2/ZONE 3	82
Zone 2/Zone 3 connections.....	82
Controlling Zone 2/Zone 3 from the front panel	83
Controlling Zone 2/Zone 3 using the remote control.....	84
FRONT PANEL DISPLAY MENUS	86
Advanced setup menu.....	86
Front panel display system options menu.....	87
USING i.LINK	91
What is i.LINK?	91
Connecting i.LINK components.....	91
Basic i.LINK operations	92
Changing i.LINK Select parameters	92
i.LINK display messages	94
USING HDMI	95
What is HDMI?	95
Connecting HDMI components.....	96
Basic HDMI operations	97
Changing HDMI parameters.....	97

ADDITIONAL INFORMATION

EDITING SOUND FIELD PARAMETERS	99
What is a sound field?	99
Changing parameter settings	99
SOUND FIELD PARAMETER	
DESCRIPTIONS	100
TROUBLESHOOTING	105
GLOSSARY	110
Audio formats	110
Sound field programs.....	111
Audio information	111
Video signal information	113
PARAMETRIC EQUALIZER	
INFORMATION	114
SPECIFICATIONS	115

INTRODUCTION

PREPARATION

BASIC OPERATION

SOUND FIELD PROGRAMS

ADVANCED OPERATION

ADDITIONAL INFORMATION

FEATURES

Built-in 7-channel power amplifier

- ◆ Minimum RMS Output Power (0.04% THD, 20 Hz to 20 kHz, 8 Ω)
Front: 130 W + 130 W
Center: 130 W
Surround: 130 W + 130 W
Surround Back: 130 W + 130 W

Sound field features

- ◆ Proprietary YAMAHA technology for the creation of sound fields
- ◆ THX Select2
- ◆ SRS CS II (U.S.A. model only)
- ◆ Dolby Digital/Dolby Digital EX decoder
- ◆ DTS/DTS-ES Matrix 6.1, Discrete 6.1, DTS Neo:6 decoder, DTS 96/24
- ◆ Dolby Pro Logic/Dolby Pro Logic II/Dolby Pro Logic IIx decoder
- ◆ Virtual CINEMA DSP
- ◆ SILENT CINEMA™

Sophisticated AM/FM tuner

- ◆ 40-station random access preset tuning
- ◆ Automatic preset tuning
- ◆ Preset station shifting capability (preset editing)
- ◆ HD Radio™ digital broadcast reception capability

Other features

- ◆ YPAO: YAMAHA Parametric Room Acoustic Optimizer for automatic speaker setup
- ◆ 192-kHz/24-bit D/A converter
- ◆ GUI (graphical user interface) menus that allow you to optimize this unit to suit your individual audio/video system
- ◆ 6 or 8-channel additional input jacks for discrete multi-channel input
- ◆ Short message function
- ◆ PURE DIRECT for pure fidelity sound with analog, DSD, PCM and multi-channel PCM sources
- ◆ S-video signal input/output capability
- ◆ Component video input/output capability
- ◆ Video signal conversion (composite video ↔ S-video → component video) capability for monitor out
- ◆ i.LINK interface for direct digital transfer of digital audio signals
- ◆ HDMI interface for standard, enhanced or high-definition video as well as multi-channel digital audio
- ◆ Optical and coaxial digital audio signal jacks
- ◆ Sleep timer
- ◆ Cinema and music night listening mode
- ◆ Remote control with preset remote control codes and learning/macro capability
- ◆ Zone 2/Zone 3 custom installation facility
- ◆ Zone 2/Zone 3 remote control for controlling Zone 2/Zone 3 components connected to this unit

•  indicates a tip for your operation.

- Some operations can be performed by using either the buttons on the main unit or on the remote control. In cases when the button names differ between the main unit and the remote control, the button name on the remote control is given in parentheses.
- This manual is printed prior to production. Design and specifications are subject to change in part as a result of improvements, etc. In case of differences between the manual and product, the product has priority.



Manufactured under license from Dolby Laboratories. “Dolby”, “Surround EX”, and the double-D symbol are trademarks of Dolby Laboratories.



“DTS”, “DTS-ES”, “Neo:6” and “DTS 96/24” are trademarks of Digital Theater Systems, Inc.



“HDMI”, the “HDMI” logo and “High-Definition Multimedia Interface” are trademarks or registered trademarks of HDMI Licensing LLC.



HD Radio™ technology manufactured under license from iBiquity Digital Corporation. “iBiquity Digital” and the “HD Radio” and “HD” symbols are registered trademarks of iBiquity Digital Corporation. U.S. and Foreign Patents.

“i.LINK” and the “i.LINK” logo  are trademarks of Sony Corporation.

SILENT™
CINEMA

“SILENT CINEMA” is a trademark of YAMAHA CORPORATION.



Circle Surround II, Dialog Clarity, TruBass, SRS and the  symbol are trademarks of SRS Labs, Inc.

Circle Surround II, Dialog Clarity and TruBass technologies are incorporated under license from SRS Labs, Inc.



The THX logo is a trademark of THX Ltd. which may be registered in some jurisdictions. All rights reserved.

GETTING STARTED

Supplied accessories

Please check that you received all of the following parts.

Remote control

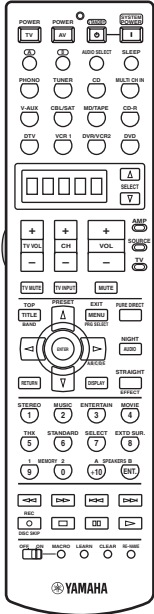

Zone 2/Zone 3 remote control

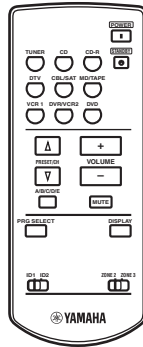

**Batteries (4)
(AAA, LR03)**

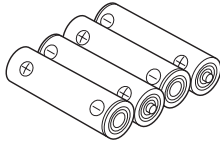

**Batteries (2)
(AAA, R03)**

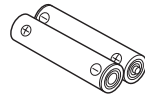

Power cable

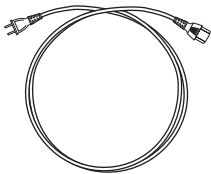

Speaker terminal wrench

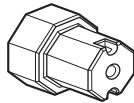

Optimizer microphone

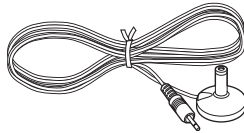

75-ohm/300-ohm antenna adapter (U.K. model only)

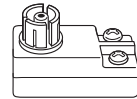

AM loop antenna (U.S.A. model)

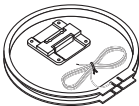

AM loop antenna (Canada, Asia, General, China, Korea, Australia, U.K. and Europe models)

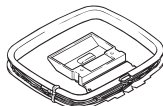

Indoor FM antenna (U.S.A., Canada, Asia, General, China and Korea models)

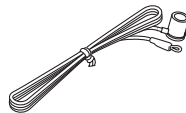

Indoor FM antenna (Australia, U.K. and Europe models)

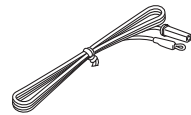

Installing batteries in the remote controls

Notes on batteries

- Change all of the batteries if you notice conditions such as the operation range of the remote control decreases, the indicator does not flash, or its light or display window become dim.
- Do not use old batteries together with new ones.
- Do not use different types of batteries (such as alkaline and manganese batteries) together. Read the packaging carefully as these different types of batteries may have the same shape and color.
- If the batteries have leaked, dispose of them immediately. Avoid touching the leaked material or letting it come into contact with clothing, etc. Clean the battery compartment thoroughly before installing new batteries.
- Do not throw away batteries with general house waste; dispose of them correctly in accordance with your local regulations.

■ Remote control

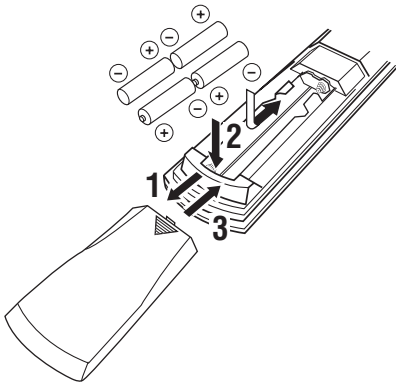

- 1 Press the ▼ part and slide the battery compartment cover off.
- 2 Insert four supplied batteries (AAA, LR03) according to the polarity markings on the inside of the battery compartment.
- 3 Slide the cover back until it snaps into place.

If the remote control is without batteries for more than 2 minutes, or if exhausted batteries remain in the remote control, the contents of the memory may be cleared. When the memory is cleared, insert new batteries, set up the remote control code and program any acquired functions that may have been cleared.

■ Zone 2/Zone 3 remote control

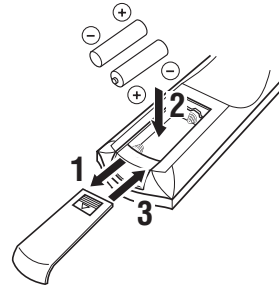

- 1 Press the ▼ part and slide the battery compartment cover off.
- 2 Insert two supplied batteries (AAA, R03) according to the polarity markings (+ and -) on the inside of the battery compartment.
- 3 Slide the cover back until it snaps into place.

CONTROLS AND FUNCTIONS

Front panel

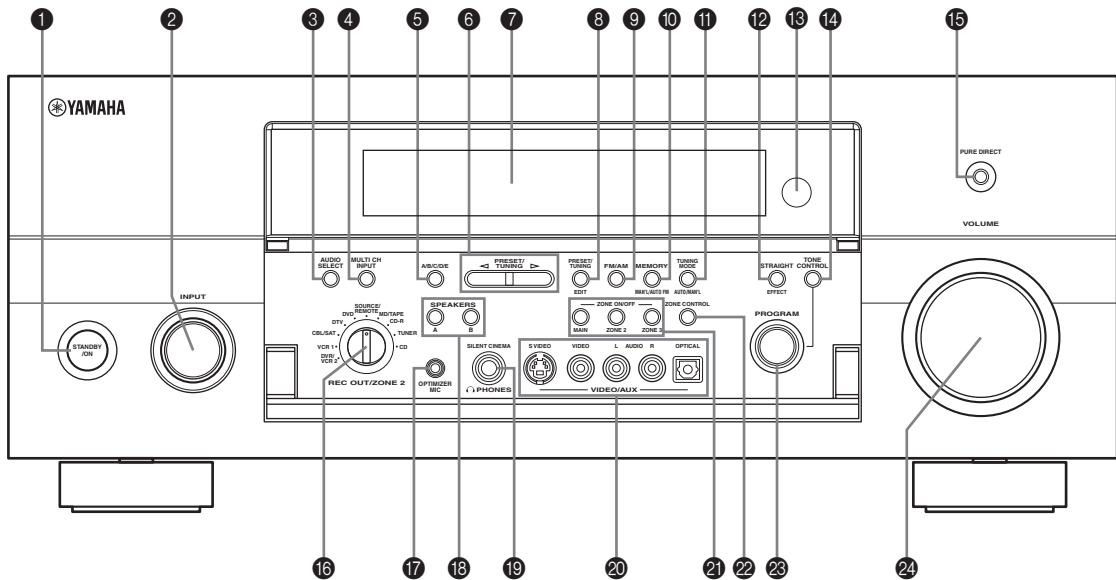

1 STANDBY/ON

Turns on the main unit only or sets it to the standby mode. When you turn on the main unit, there will be a 6 to 7 second delay before the main unit can reproduce sound.

Notes

- In the standby mode, this unit consumes a small amount of power in order to receive infrared-signals from the remote control.
- You can turn on the main unit, Zone 2 and Zone 3 or set them to the standby mode simultaneously using the remote control. For details, see page 85.

2 INPUT selector

Selects the input source you want to listen to or watch.

3 AUDIO SELECT

Toggles the priority for the type of audio input jack (AUTO, i.LINK, HDMI, COAX/OPT, ANALOG) when one component is connected to two or more input jacks on this unit (see page 40).

4 MULTI CH INPUT

Selects the source connected to the MULTI CH INPUT jacks. When selected, the MULTI CH INPUT source takes priority over the source selected with the INPUT selector (or the input selector buttons on the remote control).

5 A/B/C/D/E

Selects one of the 5 preset station groups (A to E) when the unit is in the tuner mode (see page 44).

6 PRESET/TUNING </>

Selects preset station number 1 to 8 when the unit is in the tuner mode and the colon (:) is displayed next to the band indication in the front panel display. Selects the tuning frequency when the unit is in the tuner mode and the colon (:) is not displayed. See pages 41 to 44 for details.

7 Front panel display

Shows information about the operational status of this unit.

8 PRESET/TUNING (EDIT)

Switches the function of PRESET/TUNING </> between selecting preset station numbers and tuning when the unit is in the tuner mode (see pages 41 to 44).

9 FM/AM

Switches the reception band (FM or AM) when the unit is in the tuner mode (see page 41).

10 MEMORY (MAN'L/AUTO FM)

Stores a station in the memory when the unit is in the tuner mode. Hold down this button for more than 3 seconds to start automatic preset tuning (see pages 42 to 43).

11 TUNING MODE (AUTO/MAN'L)

Switches the tuning mode between automatic ("AUTO" indicator on) and manual ("AUTO" indicator off) when the unit is in the tuner mode.

12 STRAIGHT/EFFECT

Switches the sound fields off or on. When STRAIGHT is selected, input signals (2-channel or multi-channel) are output directly from their respective speakers without effect processing.

13 Remote control sensor

Receives signals from the remote controls.

14 TONE CONTROL

Use to adjust the bass/treble balance for the front left/right and center channels (see page 35).

15 PURE DIRECT

Turns on or off the PURE DIRECT mode. Lights up when turned on (see page 38).

16 REC OUT/ZONE 2

Selects the source you want to direct to the audio/video recorder and ZONE 2 outputs independently of the source you are listening to or watching in the main room. When set to the SOURCE/REMOTE position, the input source is directed to all outputs. The source in Zone 2 and the source you record are always identical.

17 OPTIMIZER MIC jack

Use to connect and input audio signals from the supplied microphone for use with the AUTO SETUP function (see page 27).

18 SPEAKERS A/B

Turn on or off the set of front speakers connected to the A and/or B terminals on the rear panel each time the corresponding button is pressed.

19 PHONES (SILENT CINEMA) jack

Outputs audio signals for private listening with headphones. When you connect headphones, no signals are output at the PRE OUT jacks or to the speakers. All Dolby Digital and DTS audio signals are mixed down to the front left and right channels.

20 VIDEO AUX jacks

Input audio and video signals from an external source such as a game console. To reproduce source signals at these jacks, select V-AUX as the input source.

21 ZONE ON/OFF

MAIN

Turns on the power of the main unit or sets it to the standby mode (see page 83).

ZONE 2

Turns on the power of Zone 2 or sets it to the standby mode (see page 83).

ZONE 3

Turns on the power of Zone 3 or sets it to the standby mode (see page 83).

22 ZONE CONTROL

Press to control the input or adjust the volume level for the currently selected zone (the main unit, Zone 2 or Zone 3) (see page 83). After you press ZONE CONTROL, the indicator for the currently selected zone flashes in the front panel display for approximately 5 seconds. While the indicator is flashing, perform the desired operation.

23 PROGRAM selector

Use to select sound field programs or adjust bass/treble balance (in conjunction with TONE CONTROL).

24 VOLUME

Controls the output level of all audio channels. This does not affect the REC OUT level.

Opening and closing the front panel door

When you want to use the controls behind the front panel door, open the door by gently pressing on the lower part of the panel. Keep the door closed when not using these controls.

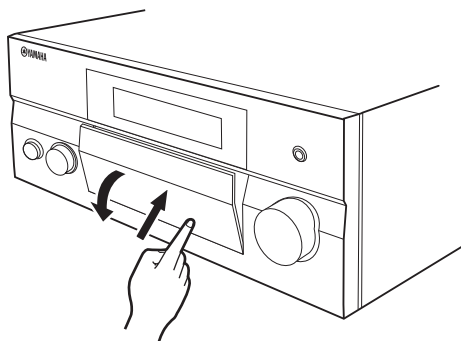

To open, press gently on the lower part of the panel.

Remote control

This section describes the function of each control on the remote control used to control this unit. To operate other components, see “REMOTE CONTROL FEATURES” on page 70. Set AMP/SOURCE/TV to AMP to operate this unit.

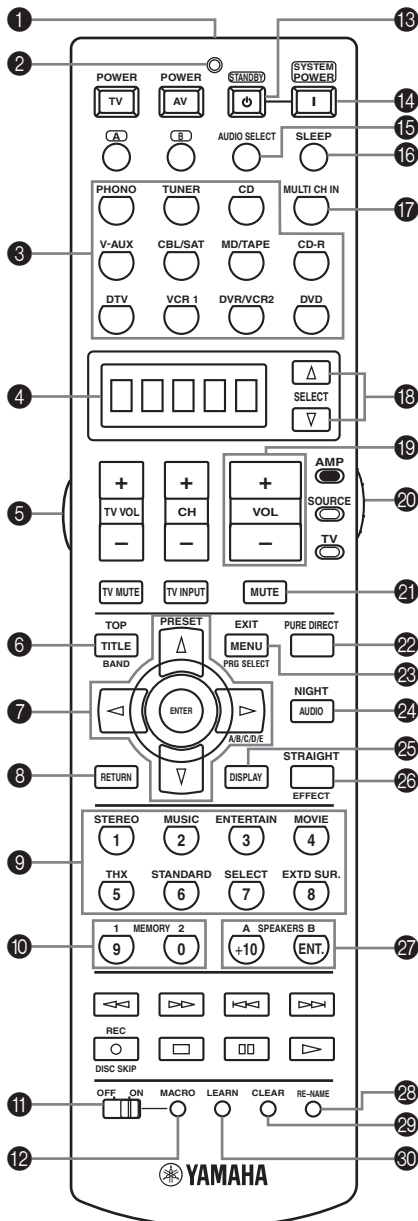

1 Infrared window

Outputs infrared control signals. Aim this window at the component you want to operate.

2 Transmission indicator

Flashes while the remote control is sending signals.

3 Input selector buttons

Select the input source and change the control area. Set AMP/SOURCE/TV to SOURCE, then press TUNER to select the TUNER mode.

4 Display window

Shows the name of the selected source component that you can control.

5 LIGHT button

Press to light up remote control buttons and display window.

6 TOP, BAND

Displays the top screen in the graphical user interface (GUI) menu on your video monitor when AMP/SOURCE/TV is set to AMP.

Switches the reception band (FM or AM) when AMP/SOURCE/TV is set to SOURCE and the unit is in the tuner mode.

7 Cursor buttons Δ / ∇ / \triangleleft / \triangleright / ENTER

Use to select and adjust DSP program parameters or GUI menu items when AMP/SOURCE/TV is set to AMP.

Press \triangleleft / \triangleright to select a preset station group (A to E) when AMP/SOURCE/TV is set to SOURCE and the unit is in the tuner mode.

Press Δ / ∇ to select a preset station number (1 to 8) when AMP/SOURCE/TV is set to SOURCE and the unit is in the tuner mode.

8 RETURN

Returns to the upper directory when in the front panel display menu mode.

9 Sound field program / numeric buttons

Use to select sound field programs or input numbers when AMP/SOURCE/TV is set to AMP.

Use numbers 1 through 8 to select preset stations when AMP/SOURCE/TV is set to SOURCE and the unit is in the tuner mode.

Use SELECT to play back 2-channel sources in multi-channel format (see page 37).

Use EXTD SUR. to switch between 5.1 or 6.1/7.1 channel playback of multi-channel software (see page 36).

10 MEMORY 1/2

Use to recall favorite sound field programs, YPAO settings or additional preset stations (see page 69).

11 MACRO ON/OFF

Turns the macro function on and off.

12 MACRO

Use to program a series of operations for control by a single button (see page 76).

13 STANDBY

Sets this unit in the standby mode.

14 SYSTEM POWER

Turns on the power of this unit.

15 AUDIO SELECT

Toggles the priority for the type of audio input jack (AUTO, i.LINK, HDMI, COAX/OPT, ANALOG) when one component is connected to two or more input jacks on this unit (see page 40).

16 SLEEP

Sets the sleep timer.

17 MULTI CH IN

Selects MULTI CH INPUT when using an external decoder (etc.).

18 SELECT Δ / ∇

Selects another component that you can control independently of the input component selected with the input selector buttons.

19 VOL +/-

Increases or decreases the volume level.

20 AMP/SOURCE/TV

Selects the component you want to control with the remote control.

AMP: Set to this position to operate this unit.

SOURCE: Set to this position to operate the component selected with an input selector button.

TV: Set to this position to operate the television.

To set the remote control codes for components, see page 71.

21 MUTE

Mutes the sound. Press again to restore the audio output to the previous volume level.

22 PURE DIRECT

Turns on or off PURE DIRECT mode (see page 38).

23 EXIT, PRG SELECT

Use to exit the graphical user interface (GUI) mode when AMP/SOURCE/TV is set to AMP.

(U.S.A. model only)

Selects the HD Radio audio program when AMP/SOURCE/TV is set to SOURCE and the unit is in the tuner mode (see page 46).

24 NIGHT

Turns on or off the night listening modes (see page 38).

25 DISPLAY

Use to enter into the front panel display menu mode when AMP/SOURCE/TV is set to AMP.

(U.S.A. model only)

Toggles between HD Radio information displays when AMP/SOURCE/TV is set to SOURCE and the unit is in the tuner mode (see page 46).

26 STRAIGHT/EFFECT

Switches the sound fields off or on. When STRAIGHT is selected, input signals (2-channel or multi-channel) are output directly from their respective speakers without effect processing.

27 SPEAKERS A/B

Use to turn on or off the set of front speakers connected to the A and/or B terminals on the rear panel when AMP/SOURCE/TV is set to AMP, then the corresponding button is pressed each time.

28 RE-NAME

Used to change the input source name in the display window (see page 75).

29 CLEAR

Used to clear functions acquired when using the learn, macro and rename features, or setting remote control codes (see page 78).

30 LEARN

Used to set up the remote control code or program functions from other remote controls (see page 73).

Zone 2/Zone 3 remote control

This section describes the controls and functions of the Zone 2/Zone 3 remote control. Use the Zone 2/Zone 3 remote control to control components connected to this unit in Zone 2 (the second room) or Zone 3 (the third room).

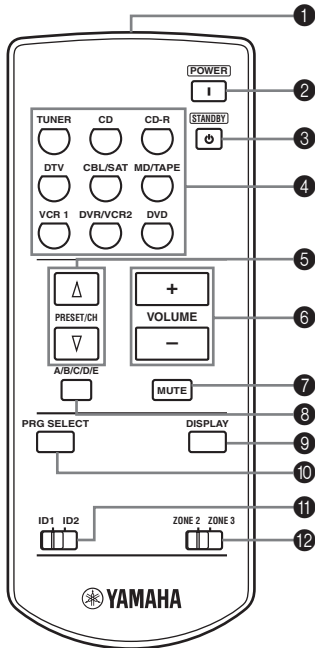

1 Infrared window

Outputs infrared control signals. Aim this window at the component you want to operate.

2 POWER

Turns on the power of this unit.

3 STANDBY

Sets this unit in the standby mode.

4 Input selector buttons

Select the input source and change the control area.

5 PRESET/CH Δ / ∇

Press Δ / ∇ to select a preset station number (1 to 8) when the unit is in tuner mode.

6 VOLUME +/-

Increases or decreases the volume level.

7 MUTE

Mutes the sound. The MUTE indicator turns on when the MUTE function is on. Press again to restore the audio output to the previous volume level.

8 A/B/C/D/E

Press repeatedly to select a preset station group (A to E) when the unit is in tuner mode.

9 DISPLAY

Use to enter into the front panel display menu mode.

(U.S.A. model only)

Toggles between HD Radio information displays when the unit is in the tuner mode (see page 46).

10 PRG SELECT

(U.S.A. model only)

Selects the HD Radio audio program when the unit is in the tuner mode (see page 46).

11 ID1/ID2

Slide to set the remote control AMP/tuner ID for this unit (see page 72).

12 ZONE 2/ZONE 3

Slide to set the operation of this unit to Zone 2 or Zone 3 (see page 82).

Using the remote controls

The remote controls transmit a directional infrared ray. Be sure to aim the remote controls directly at the remote control sensor on the main unit during operation.

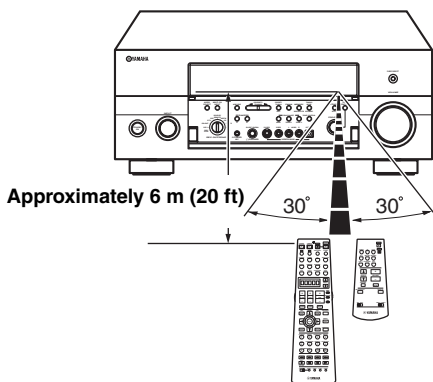

Handling the remote controls

- Do not spill water or other liquids on the remote controls.
- Do not drop the remote controls.
- Do not leave or store the remote controls in the following types of conditions:
 - places of high humidity, such as near a bath
 - places of high temperatures, such as near a heater or stove
 - extremely low temperatures
 - dusty places

Front panel display

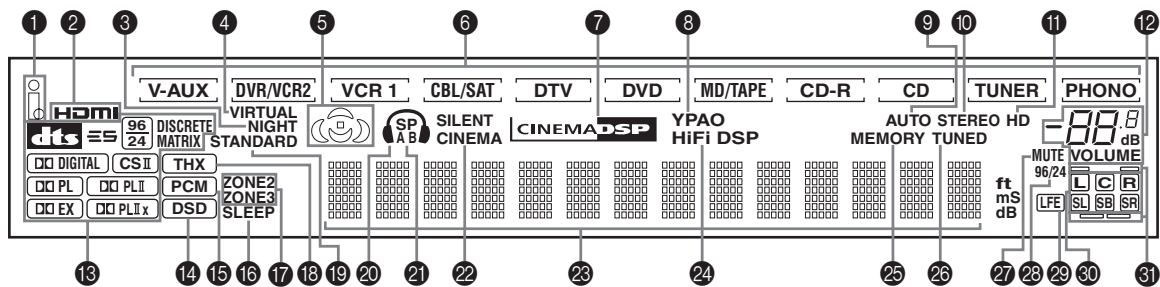

1 i.LINK indicator

Lights up when an i.LINK component is connected, and this unit is playing back signals input via i.LINK connections.

Flashes when an i.LINK component is connected, but this unit is playing back signals input via connections other than i.LINK or no signals are being input via i.LINK connections.

Turns off when no i.LINK component is connected. See page 94 for details.

2 HDMI indicator

Lights up when an HDMI component is connected, and this unit is playing back audio signals input via HDMI connections.

Flashes when an HDMI component is connected, but this unit is playing back audio signals input via connections other than HDMI or no audio signals are being input via HDMI connections.

Turns off when no HDMI component is connected. See page 96 for details.

3 NIGHT indicator

Lights up when you select night listening mode.

4 VIRTUAL indicator

Lights up when Virtual CINEMA DSP is active (see page 39).

5 Sound field indicators

Light to indicate the active DSP sound fields.

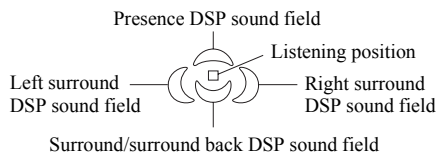

6 Input source indicators

A cursor lights to show the current input source.

7 CINEMA DSP indicator

Lights up when you select a CINEMA DSP sound field program.

8 YPAO indicator

Lights up during the auto setup procedure and when the auto setup speaker settings are used without any modifications.

9 AUTO indicator

Lights up when this unit is in the automatic tuning mode.

10 STEREO indicator

Lights up when this unit is receiving a stereo signal for an FM stereo broadcast while the AUTO indicator is lit.

11 HD Radio indicator (U.S.A. model only)

Lights up when this unit is tuned into the HD Radio reception band.

12 VOLUME level indicator

Indicates the volume level.

13 Decoder indicators

When any of this unit's decoders function, the respective indicator lights up.

14 DSD indicator

Lights up when this unit is reproducing DSD (direct stream digital) digital audio signals.

15 PCM indicator

Lights up when this unit is reproducing PCM (pulse code modulation) digital audio signals.

16 SLEEP indicator

Lights up while the sleep timer is on.

17 ZONE 2/ZONE 3 indicators

Light up when Zone 2 or Zone 3 power is on.

18 THX indicator

Lights up when a THX program is selected.

19 STANDARD indicator

Lights up when a decoder is selected (see page 37).

20 Headphones indicator

Lights up when headphones are connected.

21 SP A B indicators

Light up according to the set of front speakers selected. Both indicators light up when both sets of speakers are selected, or when bi-wiring.

22 SILENT CINEMA indicator

Lights up when headphones are connected and a sound field program is selected (see page 36).

23 Multi-information display

Shows the current sound field program name and other information when adjusting or changing settings.

24 HiFi DSP indicator

Lights up when you select a HiFi DSP sound field program.

25 MEMORY indicator

Flashes to show a station can be stored.

26 TUNED indicator

Lights up when this unit is tuned into a station.

27 MUTE indicator

Flashes while the MUTE function is on.

28 96/24 indicator

Lights up when a DTS 96/24 signal is input to this unit.

29 LFE indicator

Lights up when the input signal contains an LFE signal.

30 Input channel indicators

Indicate the channel components of current digital input signal.

31 Presence and surround back speaker indicators

Indicate the connection of presence and/or surround back speakers when using the Auto Setup setting (page 27) or Speaker Level setting (page 65).

Rear panel

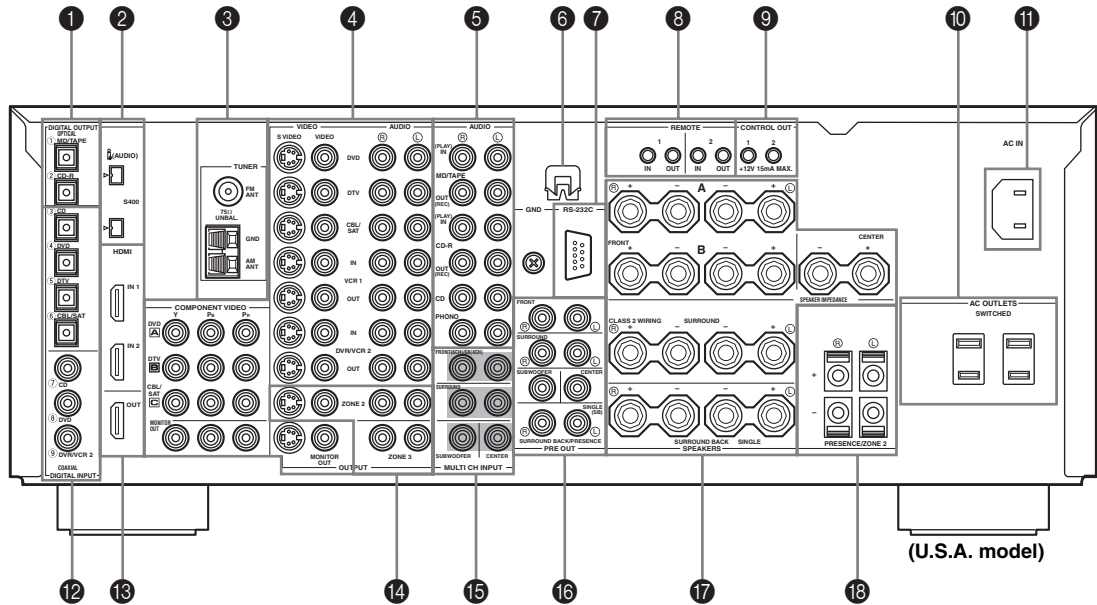

(U.S.A. model)

1 DIGITAL OUTPUT jacks

See page 22 for details.

2 i.LINK connectors

See page 91 for connection information.

3 Antenna terminals

See page 24 for connection information.

4 Video component jacks

See pages 19 and 21 for connection information.

5 Audio component jacks

See page 22 for connection information.

6 Speaker terminal wrench hook

Use to store the speaker terminal wrench when not in use.

7 RS-232C terminal

This is a control expansion terminal for factory use only. Consult your dealer for details.

8 REMOTE 1/2 IN/OUT jacks

See page 82 for details.

9 CONTROL OUT jacks

These are control expansion terminals for factory use only.

10 AC OUTLETS

Use to supply power to your other A/V components (see page 25).

11 AC INLET

Use this inlet to plug in the supplied power cable (see page 25).

12 DIGITAL INPUT jacks

See pages 19, 21 and 22 for details.

13 HDMI IN/OUT connectors

See page 95 for connection information.

14 ZONE 2/ZONE 3 OUTPUT jacks

See page 82 for details.

15 MULTI CH INPUT jacks

See page 20 for connection information.

16 PRE OUT jacks

See page 23 for connection information.

17 Speaker terminals

See page 15 for connection information.

18 PRESENCE/ZONE 2 speaker terminals

See page 15 for connection information.

SPEAKER SETUP

Speaker placement

The speaker layout below shows the standard ITU-R* speaker setting. You can use it to enjoy CINEMA DSP, multi-channel audio sources and THX.

* ITU-R is the radio communication sector of the ITU (International Telecommunication Union).

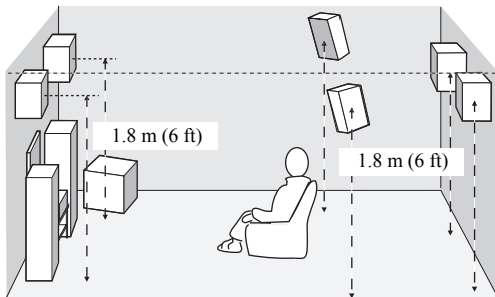
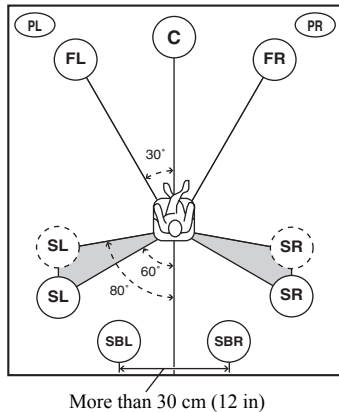

Front speakers (FR and FL)

The front speakers are used for the main source sound plus effect sounds. Place these speakers an equal distance from the ideal listening position. The distance of each speaker from each side of the video monitor should be the same.

Center speaker (C)

The center speaker is for the center channel sounds (dialog, vocals, etc.). If for some reason it is not practical to use a center speaker, you can do without it. Best results, however, are obtained with the full system. Align the front face of the center speaker with the front face of your video monitor. Place the speaker centrally between the front speakers and as close to the monitor as possible, such as directly over or under it.

Surround speakers (SR and SL)

The surround speakers are used for effect and surround sounds. Place these speakers behind your listening position, facing slightly inwards, about 1.8 m (6 ft) above the floor.

Surround back speakers (SBR and SBL)

The surround back speakers supplement the surround speakers and provide for more realistic front-to-back transitions. Place these speakers directly behind the listening position and at the same height as the surround speakers. They should be positioned at least 30 cm (12 in) apart. Ideally, they should be positioned at the same width as the front speakers.

Subwoofer

The use of a subwoofer, such as the YAMAHA Active Servo Processing Subwoofer System, is effective not only for reinforcing bass frequencies from any or all channels, but also for high fidelity reproduction of the LFE (low-frequency effect) channel included in Dolby Digital and DTS software. The position of the subwoofer is not so critical, because low bass sounds are not highly directional. But it is better to place the subwoofer near the front speakers. Turn it slightly toward the center of the room to reduce wall reflections.

Presence speakers (PR and PL)

Presence speakers supplement the sound from the front speakers with extra ambient effects produced by CINEMA DSP (see page 48). These effects include sounds that filmmakers intend to locate a little farther back behind the screen in order to create more theater-like ambience. Place these speakers at the front of the room about 0.5 – 1 m (1 – 3 ft) outside the front speakers, facing slightly inwards, and about 1.8 m (6 ft) above the floor.

Note

Surround back and presence speakers do not output sound simultaneously. You can set to prioritize either set of speakers in the Sound menu (see page 61).

■ **Di-pole speaker layout**

Either di-pole or direct radiating speaker types can be used for THX surround. If you choose di-pole speakers, please place the surround and surround back speakers according to the speaker layout below.

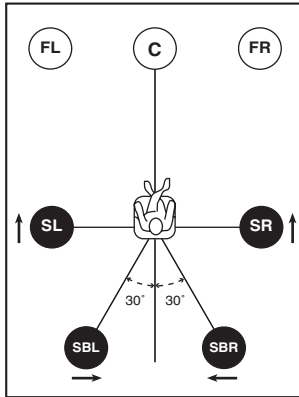

- : Di-pole speaker
- ↑ : Direction of di-pole speaker

Speaker connections

Be sure to connect the left channel (L), right channel (R), “+” (red) and “-” (black) properly. If the connections are faulty, no sound will be heard from the speakers, and if the polarity of the speaker connections is incorrect, the sound will be unnatural and lack bass.

CAUTION

- If you will use 6 ohm speakers, be sure to set this unit's speaker impedance setting to 6 ohms before using (see page 26). If you will use 8 ohm speakers, use this unit's initial setting for speaker impedance.
- Before connecting the speakers, make sure that this unit is disconnected from the power source.
- Do not let the bare speaker wires touch each other or do not let them touch any metal part of this unit. This could damage this unit and/or speakers.
- Use magnetically shielded speakers. If this type of speaker still creates interference with the monitor, place the speakers away from the monitor.

A speaker cord is actually a pair of insulated cables running side by side. One cable is colored or shaped differently, perhaps with a stripe, groove or ridges. Connect the striped (grooved, etc.) cable to the “+” (red) terminals on this unit and your speaker. Connect the plain cable to the “-” (black) terminals.

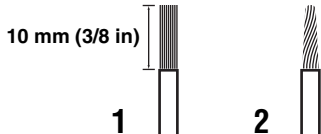

- 1 Remove approximately 10 mm (3/8 in) of insulation from each of the speaker cables.**
- 2 Twist the exposed wires of the cable together to prevent short circuits.**
- 3 Loosen the knob.**
The supplied speaker terminal wrench is useful for loosening or tightening knobs.
- 4 Insert one bare wire into the hole in the side of each terminal.**

- 5 Tighten the knob to secure the wire.**

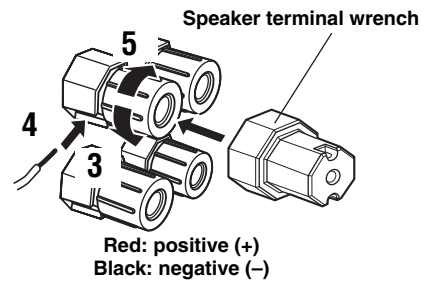

- **Connecting to PRESENCE/ZONE 2 or PRESENCE speaker terminals**

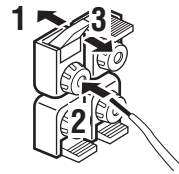

- 1 Open the tab.**
- 2 Insert one bare wire into the hole of each terminal.**
- 3 Return the tab to secure the wire.**

- **Banana plug connections**

(With the exception of U.K., Europe and Asia models) First, tighten the knob and then insert the banana plug connector into the end of the corresponding terminal.

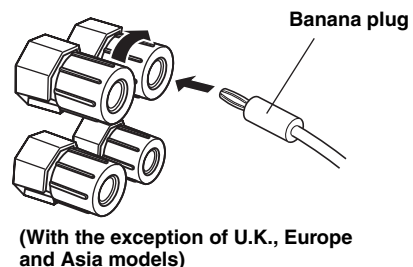

You can also use banana plugs with the PRESENCE/ZONE 2 and PRESENCE speaker terminals. Open the tab, then insert one banana plug connector into the hole of each terminal. Do not attempt to close the tabs after connecting the banana plugs.

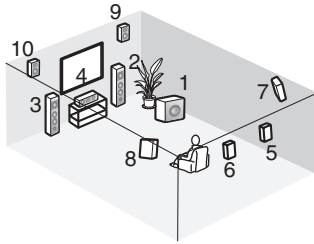

Speaker layout

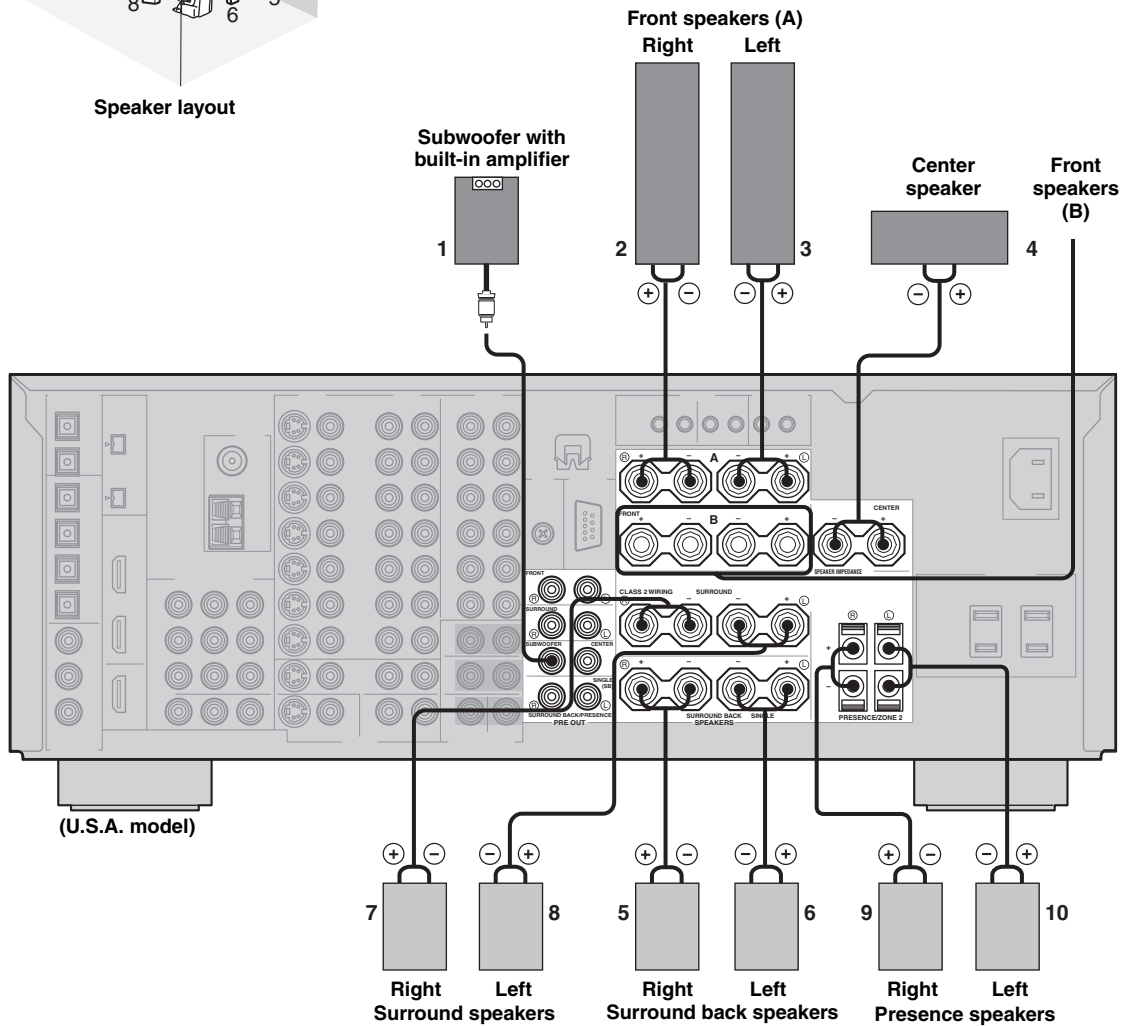

(U.S.A. model)

- You can connect both surround back and presence speakers to this unit, but they do not output sound simultaneously. You can set to prioritize either set of speakers in the Sound menu (see page 61).
- The surround back speakers output the surround back channel included in Dolby Digital EX and DTS-ES software and only operate when the Dolby Digital EX, DTS-ES or Dolby Pro Logic IIX decoder is turned on.
- The presence speakers output ambient effects created by the DSP sound fields. They do not output sound when other sound fields are selected.

■ FRONT terminals

Connect one or two speaker systems to these terminals. If you use only one speaker system, connect it to either of the FRONT A or B terminals.

Note

The Canada model cannot output to two separate speaker systems simultaneously.

■ Bi-wired connection

The unit also allows you to make bi-wired connections to one speaker system. Use two pairs of speaker cables for each speaker (one pair for the woofer and one pair for the tweeter/mid-range). To use the bi-wired connections, press SPEAKERS A and SPEAKERS B on the front panel so that both SP A and B light up on the front panel display.

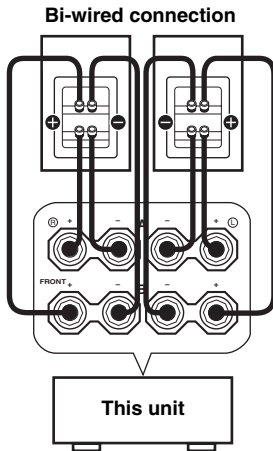

■ CENTER terminals

Connect a center speaker to these terminals.

■ SURROUND terminals

Connect surround speakers to these terminals.

■ SUBWOOFER jack

Connect a subwoofer with a built-in amplifier, such as the YAMAHA Active Servo Processing Subwoofer System, to this jack.

■ SURROUND BACK terminals

Connect surround back speakers to these terminals. If you only connect one surround back speaker, connect it to the left (L) terminals.

■ PRESENCE terminals

Connect presence speakers to these terminals.

Note

You can also use these terminals to connect Zone 2 speakers (see page 83).

CONNECTIONS

Before connecting components

CAUTION

Do not connect this unit or other components to the mains power until all connections between components are complete.

Cable indications

For analog signals

left analog cables



right analog cables



For digital signals

optical cables



coaxial cables



For video signals

video cables



S-video cables

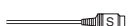

Analog jacks

You can input analog signals from audio components by connecting audio pin cables to the analog jacks on this unit. Connect red plugs to the right jacks and white plugs to the left jacks.

Digital jacks

This unit has digital jacks for direct transmission of digital signals through either coaxial or fiber optic cables. You can use the digital jacks to input PCM, Dolby Digital and DTS bitstreams. When you connect components to both the COAXIAL and OPTICAL jacks, priority is given to signals input at the COAXIAL jack. All digital input jacks are compatible with 96-kHz sampling digital signals.

Note

This unit handles digital and analog signals independently. Thus audio signals input at the analog jacks are only output at the analog OUT (REC) jacks. Likewise audio signals input at the digital (OPTICAL or COAXIAL) jacks are only output at the DIGITAL OUTPUT jacks.

Video jacks

This unit has three types of video jacks. Connection depends on the availability of input jacks on your monitor. The signals input at the S VIDEO jacks on this unit are automatically converted for output at the VIDEO jacks. When "Video Conv." is set to "On" (see page 66), signals input at the VIDEO jacks can be output at the S VIDEO and COMPONENT VIDEO jacks. Likewise, signals input at the S VIDEO jacks can also be output at the COMPONENT VIDEO jacks.



VIDEO jack

For conventional composite video signals.

S VIDEO jack

For S-video signals, separated into luminance (Y) and color (C) video signals to achieve high-quality color reproduction.

COMPONENT VIDEO jacks

For component signals, separated into luminance (Y) and color difference (P_B, P_R) to provide the best quality in picture reproduction.

Signal flow inside this unit

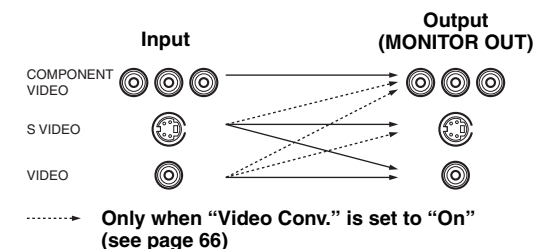

Note

When signals are input at both the S VIDEO and VIDEO jacks, signals input at the S VIDEO jack have priority.

Connecting video components

■ Connections for DVD playback

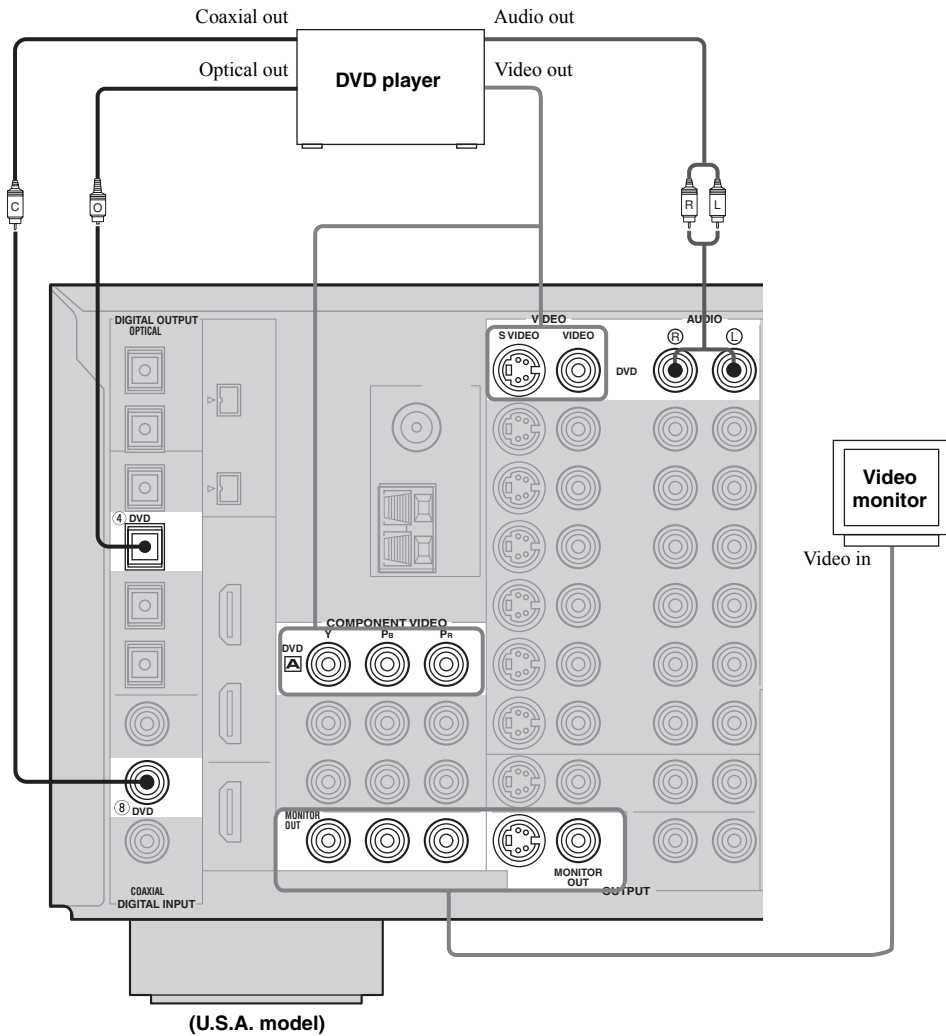

PREPARATION

■ Connecting to the MULTI CH INPUT jacks

This unit is equipped with 6 additional input jacks (left and right FRONT, CENTER, left and right SURROUND and SUBWOOFER) for discrete multi-channel input from a multi-format player, external decoder, sound processor or pre-amplifier.

If you set Multi CH Assign: Input Channels to 8ch (see page 57), you can use input jacks assigned as Multi CH Assign: Front Input (page 57) together with the MULTI CH INPUT jacks to input 8 channels.

Connect the output jacks on your multi-format player or external decoder to the MULTI CH INPUT jacks. Be sure to match the left and right outputs to the left and right input jacks for the front and surround channels.

For 6-channel input

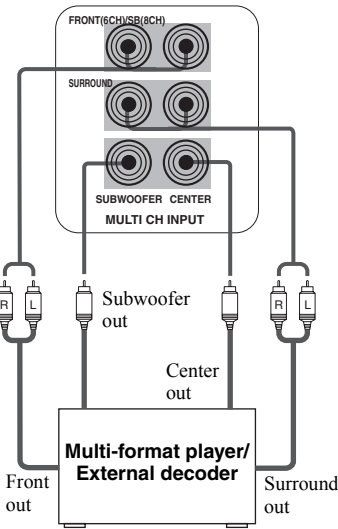

For 8-channel input

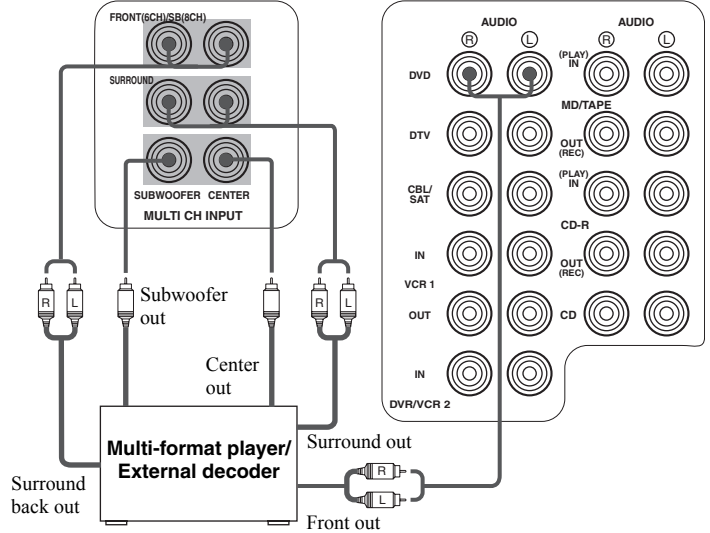

Notes

- When you select MULTI CH INPUT as the input source, this unit automatically turns off the digital sound field processor, and you cannot select sound field programs.
- This unit does not redirect signals input at the MULTI CH INPUT jacks to accommodate for missing speakers. We recommend that you connect at least a 5.1-channel speaker system before using this feature.
- When headphones are used, only front L/R channels are output.

■ Connections for other video components

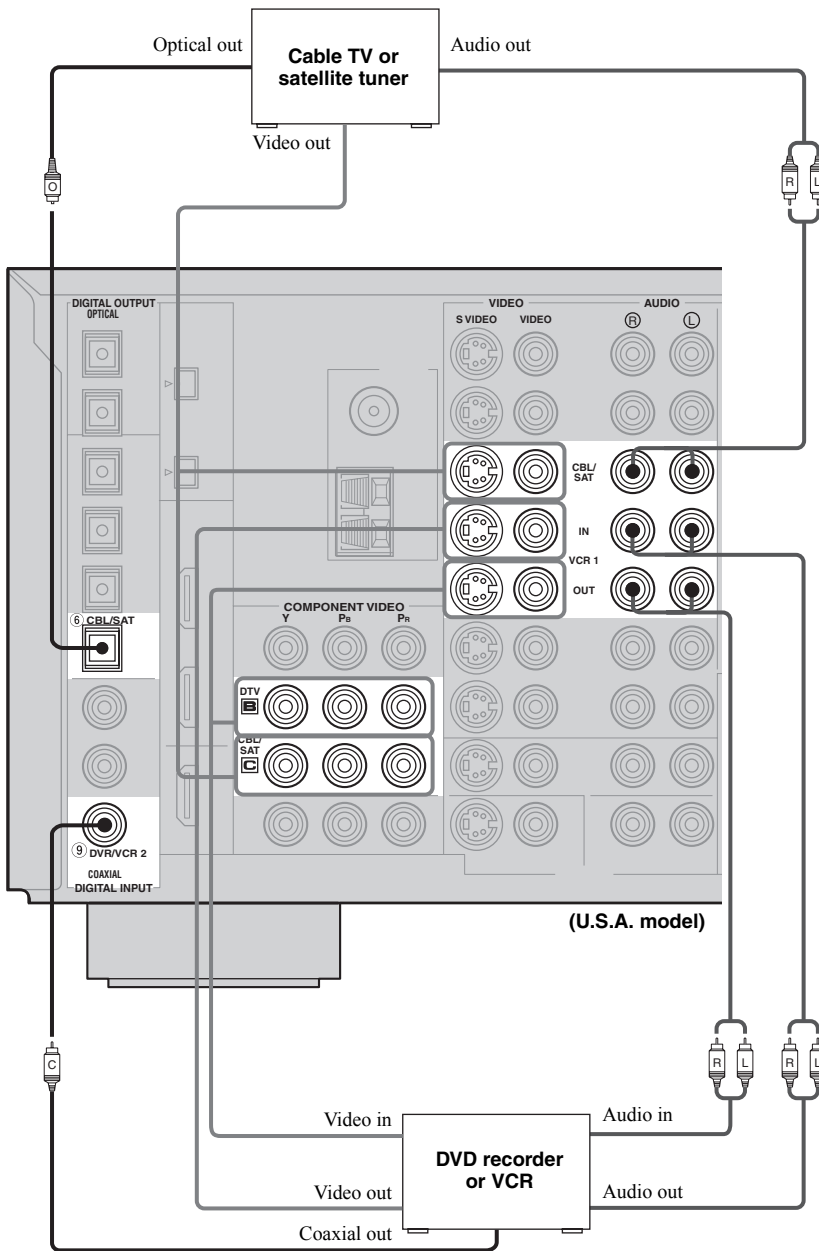

PREPARATION

■ VIDEO AUX jacks (on the front panel)

Use these jacks to connect any video source, such as a game console or video camera, to this unit.

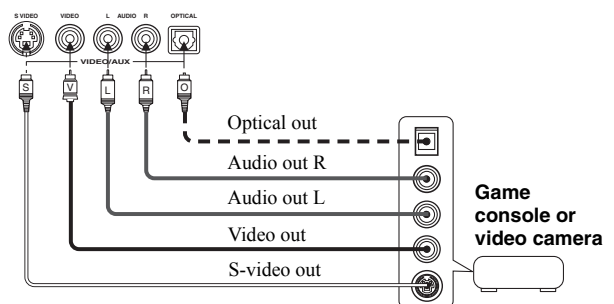

Connecting audio components

■ Connections for audio components

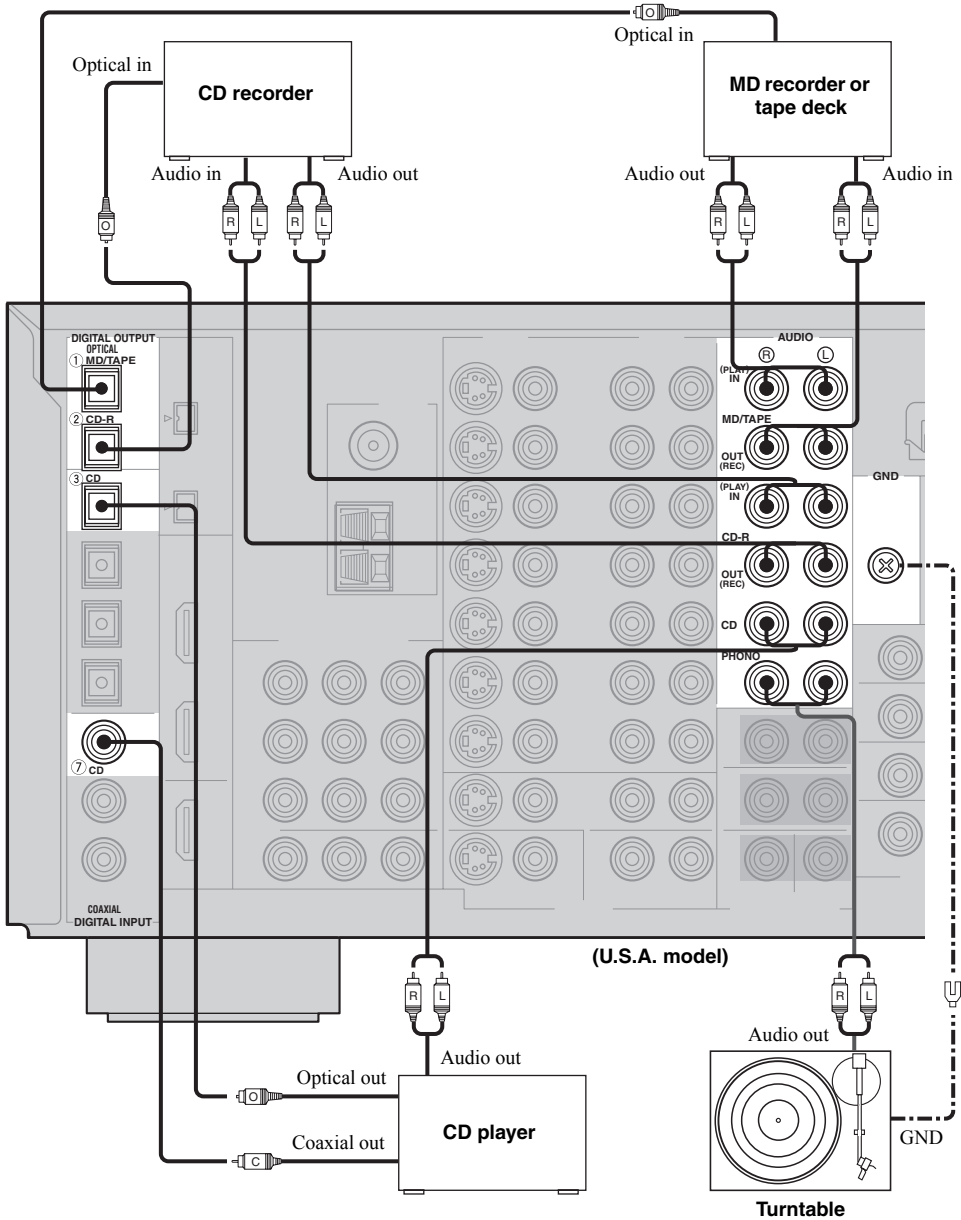

■ Connecting a turntable

PHONO jacks are for connecting a turntable with an MM or high-output MC cartridge. If you have a turntable with a low-output MC cartridge, use an in-line boosting transformer or MC-head amplifier when connecting to these jacks.



Connect your turntable to the GND terminal to reduce noise in the signal. However you may hear less noise without the connection to the GND terminal for some record players.

■ Connecting to an external amplifier

If you want to increase the power output to the speakers, or want to use another amplifier, connect an external amplifier to the PRE OUT jacks as follows.

Notes

- When audio pin plugs are connected to the PRE OUT jacks for output to an external amplifier, it is not necessary to use the corresponding SPEAKERS terminals. Set the volume of the external amplifier connected to this unit to the maximum.
- The signal output at the FRONT PRE OUT and CENTER PRE OUT jacks are affected by the TONE CONTROL settings.
- If SPEAKERS A is turned off and Multi Zone: Speaker B is set to “Zone B” (see page 67), signals will only be output at the FRONT PRE OUT jacks.

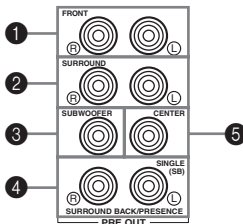

① FRONT PRE OUT jacks

Front channel line output jacks.

② SURROUND PRE OUT jacks

Surround channel line output jacks.

③ SUBWOOFER PRE OUT jack

Connect a subwoofer with built-in amplifier, such as the YAMAHA Active Servo Processing Subwoofer System, to this jack.

④ SURROUND BACK/PRESENCE PRE OUT jacks

Surround back or presence channel line output jacks. If you only connect one external amplifier for the surround back channel, connect it to the left (L) jack.

⑤ CENTER PRE OUT jack

Center channel line output jack.

Notes

- Each PRE OUT jack outputs the same channel signal as the corresponding speaker terminals. However, when both surround back and presence speakers are setup in this unit, the signals output at SURROUND BACK/PRESENCE PRE OUT jacks may not correspond to the correct speakers.
- Adjust the volume level of the subwoofer with the control on the subwoofer.
- Some signals may not be output at the SUBWOOFER PRE OUT jack depending on the Speaker Set settings (see page 62).

■ Connecting i.LINK components

If you have a component with an i.LINK connector, you can enjoy digital audio from CD, DVD, Super Audio CD and DVD-A discs.

For details on i.LINK, see “USING i.LINK” on page 91.

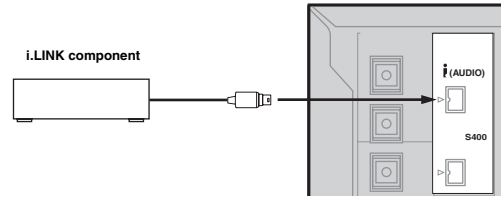

Note

An i.LINK cable shorter than 3.5 m is recommended.

■ Connecting HDMI components

This unit has the HDMI IN 1 and HDMI IN 2 jacks for signal input as well as the HDMI OUT jack for signal output. Connect the HDMI IN 1 or HDMI IN 2 jack of this unit to the HDMI OUT jack of other HDMI-compatible components (such as a DVD player). Connect the HDMI OUT jack of this unit to the HDMI IN jack of other HDMI-compatible components (such as TV and a projector).

For details on HDMI, see “USING HDMI” on page 95.

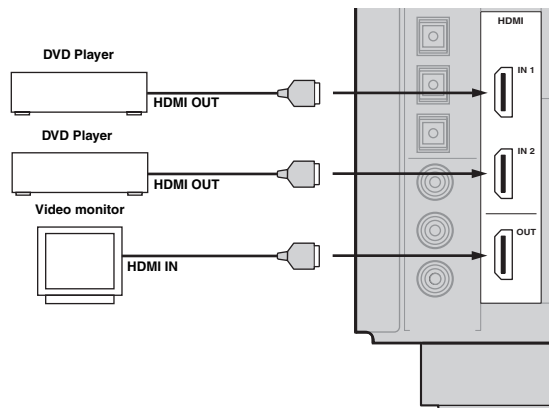

Note

An HDMI cable shorter than 5 m with the HDMI logo printed on it is recommended.

Connecting the antennas

Both AM and FM indoor antennas are included with this unit. In general, these antennas should provide sufficient signal strength. Connect each antenna correctly to the designated terminals.

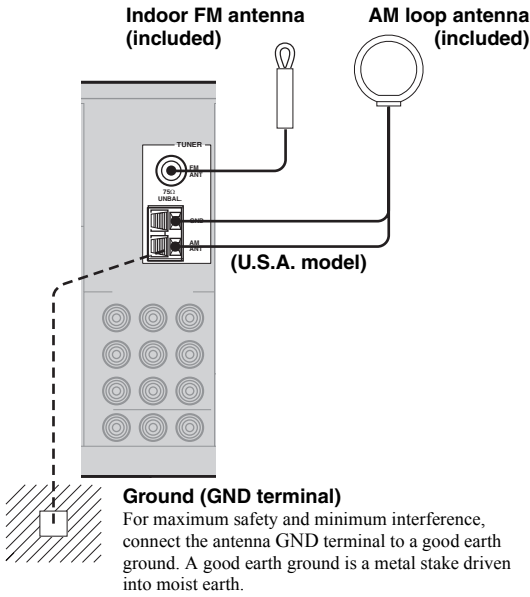

■ Connecting the AM loop antenna

1 Set up the AM loop antenna.

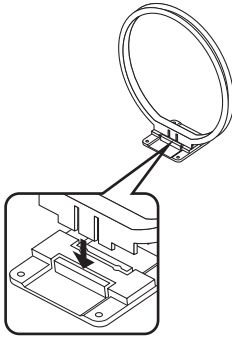

2 Press and hold the tab to insert the AM loop antenna lead wires into the AM ANT and GND terminals.

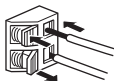

3 Orient the AM loop antenna for the best reception.

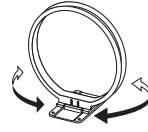

Notes

- The AM loop antenna should be placed away from this unit.
- The AM loop antenna should always be connected, even if an outdoor AM antenna is connected to this unit.
- A properly installed outdoor antenna provides clearer reception than an indoor one. If you experience poor reception quality, an outdoor antenna may improve the quality. Consult the nearest authorized YAMAHA dealer or service center about outdoor antennas.

■ 75-ohm/300-ohm antenna adapter (U.K. model only)

1 Open the cover of the included 75-ohm/300-ohm antenna adapter.

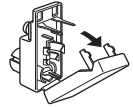

2 Cut the external sleeve of the 75-ohm coaxial cable and prepare it for connection.

11 (7/16)	Unit: mm (in)
8 (5/16)	
6 (1/4)	

3 Cut the lead wire and remove it.

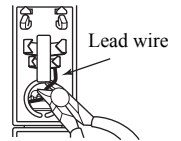

4 Insert the cable wire into the slot, and clamp it with pliers.

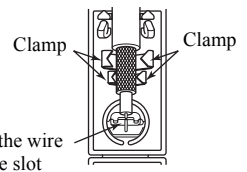

5 Snap the cover into place.

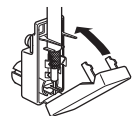

Connecting the power cable

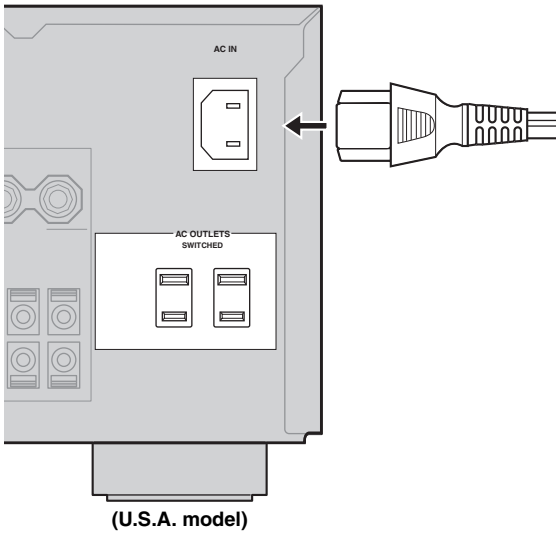

VOLTAGE SELECTOR

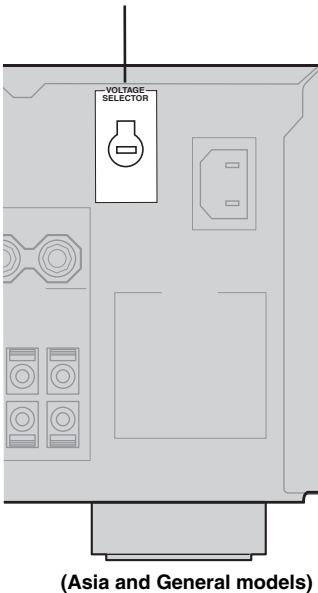

■ Connecting the AC power cable

Plug the power cable into the AC inlet after all other connections are complete, then plug the power cable to an AC wall outlet.

CAUTION

Do not use other AC power cables. Use the provided cable. Use of other power cables may result in fire hazard or electrical shock.

■ AC OUTLET(S) (SWITCHED)

U.K. and Australia models 1 outlet
 Korea model None
 Other models 2 outlets

Use these outlets to connect the power cables from your other components to this unit. Power to the AC OUTLET(S) is controlled by this unit's STANDBY/ON (or SYSTEM POWER and STANDBY). These outlets will supply power to any connected component whenever this unit is turned on. The maximum power (total power consumption of components) that can be connected to the AC OUTLET(S) is:

Asia and General models 50 W
 Other models 100 W

■ VOLTAGE SELECTOR (Asia and General models only)

The VOLTAGE SELECTOR on the rear panel of this unit must be set for your local main voltage BEFORE plugging into the AC main supply. Voltages are:

General model AC 110/120/220/230–240 V, 50/60 Hz
 Asia model AC 220/230–240V, 50/60 Hz

■ Memory back-up

The memory back-up circuit prevents the stored data from being lost even if this unit is in the standby mode. However if the power cable is disconnected from the AC wall outlet, or the power supply is cut for more than one week, the stored data will be lost.

Speaker impedance setting

Follow the procedure below to change the impedance setting for all speakers.

CAUTION

If you are using 6 ohm speakers, set the impedance to 6 ohms before using this unit.

Be sure this unit is in the standby mode.

- 1 On the front panel, while holding down STRAIGHT/EFFECT, press STANDBY/ON. "SP IMP.-8ΩMIN" appears on the front panel display.



- 2 Press STRAIGHT/EFFECT to select the impedance of your speakers. If you are using 6 ohm speakers, select 6 ohms; if you are using 8 ohm speakers, select 8 ohms.

- 3 Press STANDBY/ON to exit the setting. This unit will be set to the standby mode.

Note

Speaker impedance setting function is located in the Advanced menu (see page 86).

Turning on the power

When all connections are complete, turn on the power of this unit.

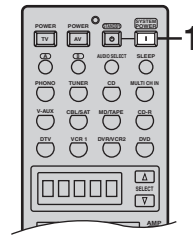
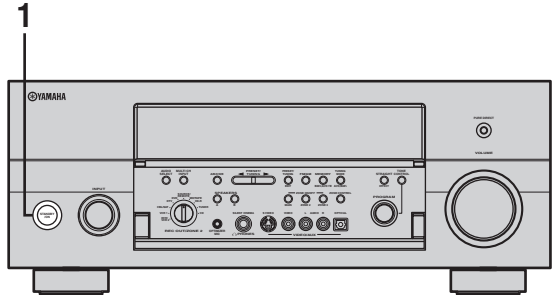

- 1 Press STANDBY/ON (or SYSTEM POWER on the remote controls) to turn on the power of this unit.



Front panel

or



Remote control

- 2 Turn on the video monitor connected to this unit.

Note

Press STANDBY/ON again (or STANDBY on the remote control) to enter the standby mode.

AUTO SETUP

Introduction

This receiver employs YAMAHA Parametric Room Acoustic Optimizer (YPAO) technology which lets you avoid troublesome listening-based speaker setup and achieves highly accurate sound adjustments. The supplied optimizer microphone collects and analyzes the sound your speakers produce in your actual listening environment.

Notes

- Please be advised that it is normal for loud test tones to be output during the auto setup procedure.
- If auto setup stops and error messages appear on the screen, follow the troubleshooting on page 31.

YPAO performs the following checks and makes appropriate adjustments to give you the best possible sound from your system.

Wiring

Checks which speakers are connected and the polarity of each speaker.

Distance

Checks the distance of each speaker from the listening position and adjusts the timing of each channel.

Size

Checks the speaker's frequency response and sets the appropriate low frequency crossover for each channel.

Equalizing

Adjusts frequency and levels of each channel's parametric equalizer to reduce coloration across the channels and create a cohesive sound field. This is particularly important if you use different brands or sizes of speakers for some channels or have a room with unique sonic characteristics.

YPAO equalizing calibration incorporates three parameters (frequency, level and Q factor) for each of the seven bands in its parametric equalizer to provide highly precise automatic adjustment of frequency characteristics.

Level

Checks and adjusts the sound level (volume) of each speaker.

Optimizer microphone setup

- 1 **Connect the supplied optimizer microphone to the OPTIMIZER MIC jack on the front panel.**

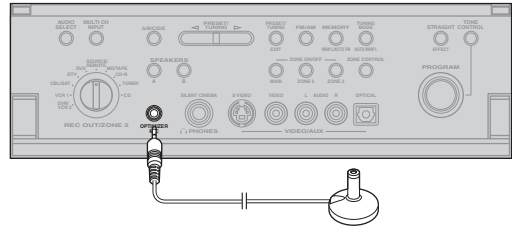

Notes

- After you have completed the auto setup procedure, be sure to disconnect the optimizer microphone.
- The optimizer microphone is sensitive to heat.
 - Keep it away from direct sunlight.
 - Do not place it on top of this unit.

- 2 **Place the optimizer microphone on a flat level surface with the omni-directional microphone head upward, at your normal listening position.**

If possible, use a tripod (etc.) to affix the optimizer mic at the same height as your ears would be when you are seated in your listening position.

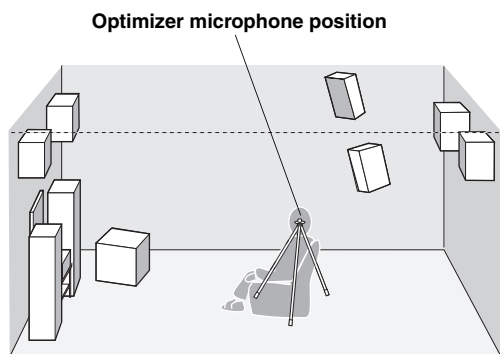

Starting the setup

For best results, make sure the room is as quiet as possible during the auto setup procedure (YPAO). If there is too much ambient noise, the results may not be satisfactory.



If your subwoofer has adjustable volume and crossover/high cut frequency controls, set the volume between 9 and 11 o'clock (as viewed on a conventional clockface) and set the crossover/high cut frequency to the maximum.

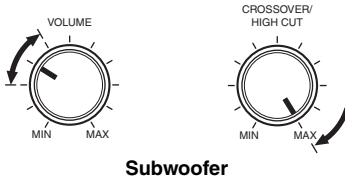

1 Switch on this unit and video monitor.

2 Set AMP/SOURCE/TV to AMP, then press **TOP** on the remote control.

The top display appears.

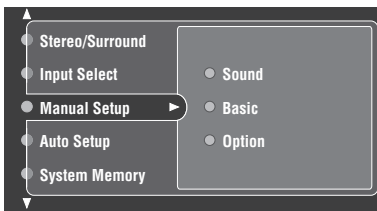

3 Press Δ / ∇ repeatedly to select Auto Setup, then press \triangleright .

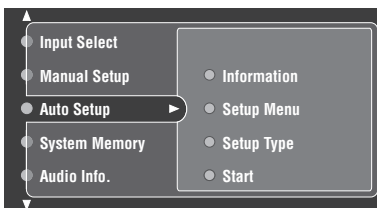
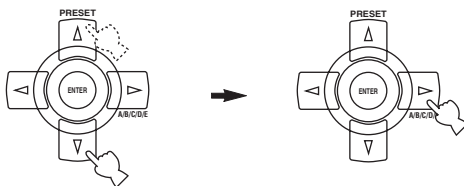

4 Press Δ / ∇ repeatedly to select Setup Menu, then press \triangleright .

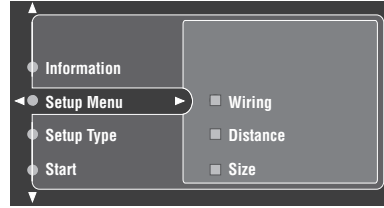

5 Press Δ / ∇ repeatedly to select Wiring, Distance, Size, Equalizing or Level, then press \triangleright .

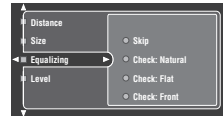
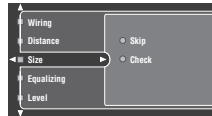

Equalizing is also available in the front panel display system options menu (see page 87).

6 For Wiring, Distance, Size or Level, select:

Check To automatically check and adjust the selected item.

Skip To skip the selected item and perform no adjustments.



When using THX speakers, select "Skip" for Size and make sure that "Small" or "Small x2" is selected in Speaker Set (page 62) and that "80Hz" is selected in Bass Cross Over (page 63).

For Equalizing, press Δ / ∇ to select:

- Skip To skip the selected item and perform no adjustments.
- Check: Natural To average out the frequency response of all speakers with higher frequencies being less emphasized. Recommended if the “Flat” setting sounds a little harsh.
- Check: Flat To average the frequency response of all speakers. Recommended if all of your speakers are of similar quality.
- Check: Front To adjust the frequency response of each speaker in accordance with the sound of your front speakers. Recommended if your front speakers are of much higher quality than your other speakers.

7 Once you have selected the desired setting, press \triangleleft to move back to Setup Menu.

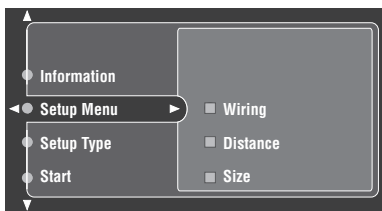

8 Press ∇ to select Setup Type, then select:

- Auto To automatically perform the entire auto setup procedure.
- Step To pause for confirmation between each check in the auto setup procedure.

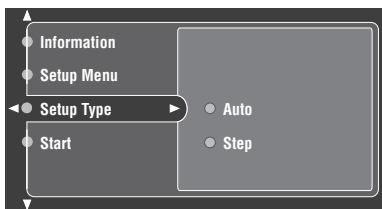

 This menu item is also available in the front panel display system options menu (see page 87).

9 Press ∇ to select Start, then press ENTER.

Loud test tones are output from each speaker and “Measuring” appears during the auto setup procedure.

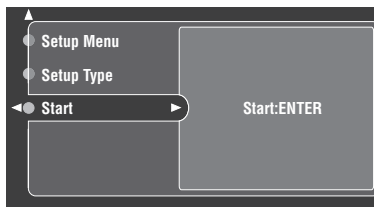

- To stop the auto setup procedure, press one of the cursor buttons (Δ / ∇ / \triangleleft / \triangleright) or ENTER. In the pause mode, press Δ to retry the procedure, \triangleleft to cancel auto setup.
- If an error message appears during testing, refer to “Troubleshooting for the auto setup procedure” on page 31, and after carrying out the remedy, retry the auto setup procedure.
- This menu item is also available in the front panel display system options menu (see page 87).

Confirming the results

You can confirm the results of each analysis.

If you set Setup Type to “Auto”

The results are displayed after all items have been analyzed.

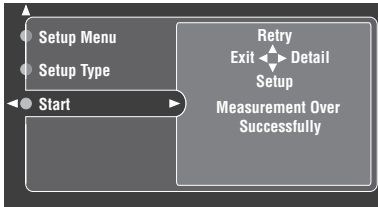

- Press ∇ and select Setup to set the measured values.
- Press Δ and select Retry to retry the auto setup procedure.
- Press \triangleright and select Detail to view information about measurement results and warning messages. For more details about warning messages, see “Troubleshooting for the auto setup procedure” on page 31.
- Press \triangleleft and select Exit to exit from the auto setup procedure. If you select Exit, “Don’t Setup?” appears on the screen. To set the measured values and exit, select Yes. To cancel the settings and exit, select No.

If you set Setup Type to “Step”

The results are displayed individually after each analysis.

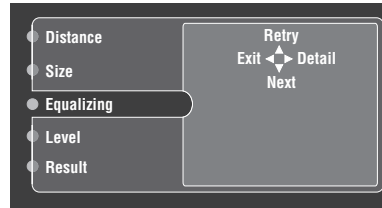

- Press ∇ and select Next to start measurement of the next menu item.
- Press Δ and select Retry to retry the auto setup procedure.
- Press \triangleright and select Detail to view information about measurement results and warning messages. For more details about warning messages, see “Troubleshooting for the auto setup procedure” on page 31.
- Press \triangleleft and select Exit to exit from the auto setup procedure. If you select Exit, “Don’t Setup?” appears on the screen. To set the measured values and exit, select Yes. To cancel the settings and exit, select No.

After all menu items have been measured, “Measurement Over” appears on the screen and the results for each item are displayed.

- Press ∇ and select Setup to set the measured values.
- Press Δ and select Retry to retry the auto setup procedure.
- Press \triangleright and select Detail to view information about measurement results and warning messages. For more details about warning messages, see “Troubleshooting for the auto setup procedure” on page 31.
- Press \triangleleft and select Exit to exit from the auto setup procedure. If you select Exit, “Don’t Setup?” appears on the screen. To set the measured values and exit, select Yes. To cancel the settings and exit, select No.



If you want to make more detailed settings, change the system parameters using the Manual Setup menu. If you want to return to the Auto Setup settings after making settings in the Manual Setup menu, navigate to the Information screen in the Auto Setup menu, press Δ / ∇ repeatedly to select the parameter you want to adjust, then press ENTER.

Notes

- If you change speakers, speaker positions, or the layout of your listening environment, perform auto setup again to re-calibrate your system.
- Depending on your listening environment, SubWfr:REV may appear in the Wiring results. In this case, SWFR Phase in the Manual Setup menu (see page 64) is automatically set to Reverse. To select the desired setting, change the SWFR Phase parameter in the Manual Setup menu.
- In the Distance results, the distance displayed may be longer than the actual distance depending on the characteristics of your subwoofer. This may also be the case when using an external amplifier.
- In the Equalizing results, different values may be set for the same band to provide finer adjustments.

■ Troubleshooting for the auto setup procedure

Before auto setup

Error message	Cause	Remedy
Connect MIC!	Optimizer microphone is not connected.	<ul style="list-style-type: none"> Connect the supplied optimizer microphone to the OPTIMIZER MIC jack on the front panel.
Unplug Phones!	Headphones are connected.	<ul style="list-style-type: none"> Unplug the headphones.
No Setup Menu!	No setup menu items have been selected.	<ul style="list-style-type: none"> Select at least one setup menu item.
Memory Guard!	This setting is protected.	<ul style="list-style-type: none"> Remove the protection setting for auto setup (see page 68).

During auto setup

Press ◀ / ▶ to display detailed information for individual errors. Select Retry to try the auto setup procedure again.

Error message	Cause	Remedy
E01:No Front SP	Front L/R channel signal(s) is (are) not detected.	<ul style="list-style-type: none"> Select the front speakers by pressing SPEAKERS A or B on the front panel (or by setting AMP/SOURCE/TV to AMP, then pressing SPEAKERS A or B on the remote control). Check the front L/R speaker connections.
E02:No Sur. SP	Only one surround channel signal is detected.	<ul style="list-style-type: none"> Check the surround speaker connections.
E03:No Pres. SP	Only one presence channel signal is detected.	<ul style="list-style-type: none"> Check the presence speaker connections.
E04:SBR ->SBL	Only the surround back right channel signal is detected.	<ul style="list-style-type: none"> Connect the surround back speaker to the LEFT SURROUND BACK SPEAKERS terminal if you only have one surround back speaker.
E05:Noisy	Background noise is too loud.	<ul style="list-style-type: none"> Try auto setup in a quiet environment. Turn off noisy electric equipment like air conditioners, or move them away from this unit.
E06:Check Sur.	Surround back speaker(s) is (are) connected, though surround L/R speakers are not.	<ul style="list-style-type: none"> Connect surround speakers when using (a) surround back speaker(s).
E07:No MIC	The optimizer microphone was unplugged during the auto setup procedure.	<ul style="list-style-type: none"> Connect the supplied optimizer microphone to the OPTIMIZER MIC jack on the front panel.
E08:No Signal	The optimizer microphone does not detect test tones.	<ul style="list-style-type: none"> Check the microphone setting. Check the speaker connections and placement.
E09:User Cancel	The auto setup procedure was cancelled because a setting that affects auto setup (such as changing speaker settings, etc.) was changed during the procedure.	<ul style="list-style-type: none"> Perform the auto setup procedure again.
E10:Internal Err	An internal error occurred.	<ul style="list-style-type: none"> Restart this unit, then try the auto setup procedure again.

After auto setup

The following warning messages are displayed after analysis is complete to inform you of possible problems. We recommend that you check the contents of each message, then select **Retry** to try the auto setup procedure again.

Warning message	Cause	Remedy
W1:Out of Phase	Speaker polarity is incorrect. This message may appear depending on the speakers even when they are connected correctly.	<ul style="list-style-type: none"> • Check the speaker connections.
W2:Over Distance	The distance between the speaker and the listening position is over 24 m (80 ft).	<ul style="list-style-type: none"> • Bring the speaker closer to the listening position.
W3:Level Error	The difference in volume level between the speakers is excessive. (No level correction is made.)	<ul style="list-style-type: none"> • Readjust the speaker installation. • Check the speaker connections. • Use speakers of similar quality. • Adjust the output volume of the subwoofer.
W4:SP Mismatch	The speaker settings differ from the measurement results of wiring (only occurs when the wiring measurement procedure is skipped).	<ul style="list-style-type: none"> • Check the speaker connections.

PLAYBACK

Basic operations

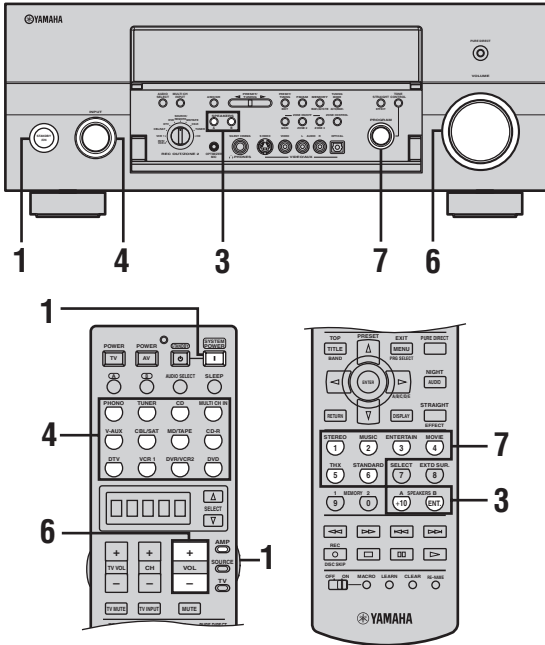

- 1 Press STANDBY/ON (or set AMP/SOURCE/TV to AMP, then press SYSTEM POWER on the remote control) to turn on the power.**



or

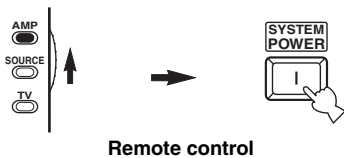

- 2 Turn on the video monitor connected to this unit.**

- 3 Press SPEAKERS A or B on the front panel (or press SPEAKERS A or B on the remote control).**

Each press turns the respective speakers on or off.

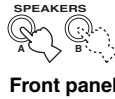

or

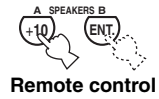

When bi-wiring, select both A and B.

- 4 Select the input source.**

Use the INPUT selector (or press one of the input selector buttons on the remote control) to select the input you desire.

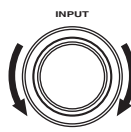

or

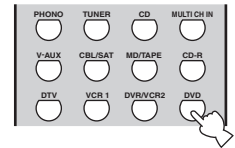

Front panel

Remote control

The current input source name appears in the front panel display and video monitor for a few seconds.



- 5 Start playback or select a broadcast station on the source component.**

Refer to the operation instructions for the component. See page 41 for details about tuning instructions.

- 6 Adjust the volume to the desired output level.**

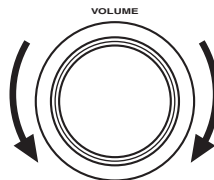

or

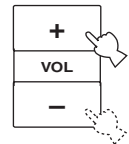

7 Select a sound field program if desired.

Use PROGRAM (or press one of the sound field program buttons repeatedly) to select a sound field program. See page 48 for details about sound field programs.



Front panel

or

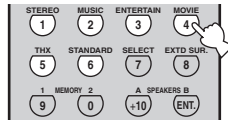

Remote control

Note

When this unit detects Dolby Digital signals, the following display appears for a few seconds. This shows how the signal level is being corrected to become -27 dB (THX recommendation).³

DialNorm = +4dB

Selecting sound field programs

■ Front panel operation

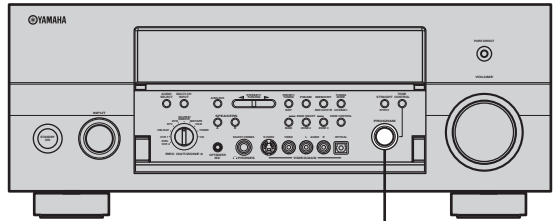

PROGRAM

Rotate PROGRAM to select the desired program.

The name of the selected program appears in the front panel display and video monitor.

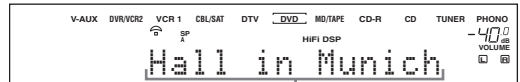

Program name

Remote control operation

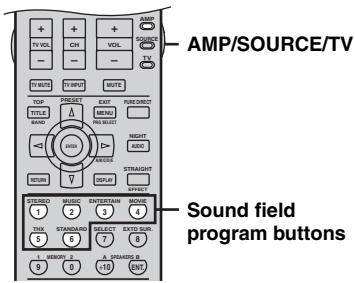

Set AMP/SOURCE/TV to AMP, then press one of the sound field program buttons repeatedly to select the desired program.

The name of the selected program appears in the front panel display and video monitor.

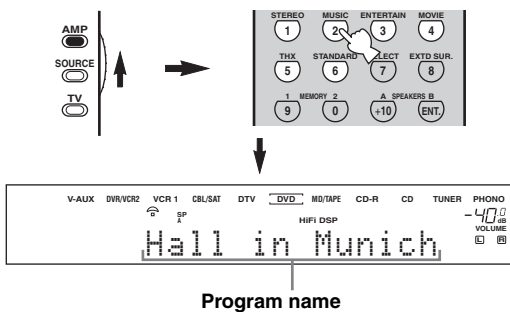

Choose a sound field program based on your listening preference, and not on the name of the program.

Notes

- When you select an input source, this unit automatically selects the last sound field program used with that source.
- Sound field programs cannot be selected when the MULTI CH INPUT is selected.

Additional operations

To adjust the tone

TONE CONTROL



↓

PROGRAM



You can adjust the bass/treble balance for the front left/right and center channels.

Press TONE CONTROL repeatedly on the front panel to select TREBLE or BASS.

Select TREBLE, then rotate PROGRAM to the right or left to increase or decrease the high-frequency response.

Select BASS, then rotate PROGRAM to the right or left to increase or decrease the low-frequency response.

To cancel the tone control, press TONE CONTROL repeatedly to select BYPASS.

Notes

- If you increase or decrease the high-frequency or the low-frequency sound to an extreme level, the tonal quality of the surround speakers may not match that of the front left/right and center speakers.
- TONE CONTROL is not effective when THX (page 48) or PURE DIRECT (page 38) is selected, or when MULTI CH INPUT is selected.
- If headphones are connected to this unit, the Tone Control setting adjusts the bass/treble balance of your headphones (see page 60).

To mute the sound

Press MUTE on the remote control.

The MUTE indicator flashes on the front panel display.

To resume the audio output, press MUTE again (or press VOL -/+).

The MUTE indicator disappears from the display.



You can adjust the muting level (see page 60).

■ To listen with headphones (“SILENT CINEMA”)

“SILENT CINEMA” allows you to enjoy multi-channel music or movie sound, including Dolby Digital and DTS surround, through ordinary headphones. “SILENT CINEMA” activates automatically whenever you connect headphones to the PHONES jack while listening to CINEMA DSP or HiFi DSP sound field programs. When activated, the “SILENT CINEMA” indicator lights up in the front panel display.

Notes

- This unit will not be set to “SILENT CINEMA” when MULTI CH INPUT is selected as the input source.
- “SILENT CINEMA” is not effective when PURE DIRECT or a 2ch Stereo program is selected, or in STRAIGHT mode.

■ Selecting the MULTI CH INPUT

Press MULTI CH INPUT so that “MULTI CH INPUT” appears in the front panel display and video monitor.

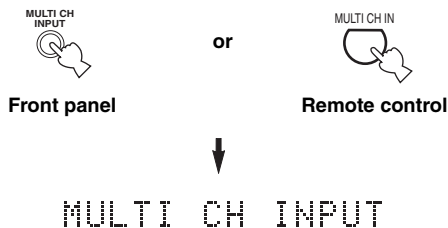

Note

When “MULTI CH INPUT” is shown on the front panel display and/or the video monitor, no other source can be played. To select another input source with the INPUT selector on the front panel (or one of the input selector buttons on the remote control), press MULTI CH INPUT to turn off “MULTI CH INPUT” from the front panel display and the video monitor.

■ Enjoying multi-channel software in 6.1/7.1 channel surround

If you connected one or two surround back speakers, use this feature to enjoy 6.1/7.1-channel playback for multi-channel sources using the Dolby Pro Logic IIx, Dolby Digital EX or DTS-ES decoders.

Set AMP/SOURCE/TV to AMP, then press EXT D SUR. on the remote control to switch between 5.1 and 6.1/7.1 channel playback.



To select a decoder, press ◀/▶ repeatedly when PLIIxMovie (etc.) is displayed.

Auto (AUTO)

When a signal (flag) that can be recognized by the unit is input, the unit selects the optimum decoder for playing back the signal in 6.1/7.1 channels.

If the unit cannot recognize the flag or no flag is present in the input signal, it cannot automatically be played in 6.1/7.1 channels.

Decoders (select with ◀/▶)

You can select from the following modes depending on the format of the software you are playing.

PLIIxMovie

For playing back Dolby Digital or DTS signals in 7.1 channels using the Pro Logic IIx movie decoder.

PLIIxMusic

For playing back Dolby Digital or DTS signals in 6.1/7.1 channels using the Pro Logic IIx music decoder.

EX/ES

For playing back Dolby Digital signals in 6.1/7.1 channels using the Dolby Digital EX decoder.

DTS signals are played back in 6.1/7.1 channels using the DTS-ES decoder.

EX

For playing back Dolby Digital or DTS signals in 6.1/7.1 channels using the Dolby Digital EX decoder.

Off (OFF)

For playing back Dolby Digital or DTS signals in 5.1 channels.



When Surround Back is set to “Large x1” or “Small x1” (see page 63), the surround back channel will output from the left SURROUND BACK speaker terminals.

Notes

- Some 6.1-channel compatible discs do not have a signal (flag) which this unit can automatically detect. When playing these kinds of discs with 6.1-channel, select decoders (PLIIxMovie, PLIIxMusic, EX/ES or EX) manually.
- 6.1/7.1-channel playback is not possible even if EXTD SUR. is pressed in the following cases:
 - When Surround or Surround Back is set to “None” (see page 63).
 - When the source connected to the MULTI CH INPUT jack is being played.
 - When the source being played does not contain surround L/R channel signals.
 - When a Dolby Digital KARAOKE source is being played.
 - When 2ch Stereo, 7ch Stereo or PURE DIRECT is selected.
- When the power of this unit is turned off, the input mode will be reset to AUTO.
- The Pro Logic IIx decoder is not available when Surround Back is set to “None” (see page 63).
- “PLIIxMovie” cannot be selected when Surround Back is set to “Large x1” or “Small x1” (see page 63).

■ Enjoying 2-channel software in surround

Signals input from 2-channel sources can also be played back on multiple channels.

Set AMP/SOURCE/TV to AMP, then press STANDARD on the remote control to switch between the SUR. STANDARD and SUR. ENHANCED programs.



Or press MOVIE or THX on the remote control to select the MOVIE THEATER or THX programs.



or



Press SELECT on the remote control to select the decoder.



You can select from the following modes depending on the type of software you are playing and your personal preference.

When you select the SUR. STANDARD program

<PRO LOGIC>

Dolby Pro Logic processing for any sources.

<PLIIx Movie>

Dolby Pro Logic IIx processing for movie software.

<PLIIx Music>

Dolby Pro Logic IIx processing for music software.

<PLIIx Game>

Dolby Pro Logic IIx processing for game software.

<Neo:6 Cinema>

DTS processing for movie software.

<Neo:6 Music>

DTS processing for music software.

<CS II Cinema>*

SRS Circle Surround II processing for movie software.

<CS II Music>*

SRS Circle Surround II processing for music software.

* (U.S.A. model only)

When you select the SUR. ENHANCED, MOVIE THEATER or THX programs

<PRO LOGIC>

Dolby Pro Logic processing for any sources.

<PLIIx Movie>

Dolby Pro Logic IIx processing for movie software.

<Neo:6 Cinema>

DTS processing for movie software.



- You can also select a decoder with the Decode Type parameter in the Stereo/Surround menu (see page 99).
- You can also select a decoder by pressing < / > on the remote control when the decoder type is displayed in the short message display.

Note

The Pro Logic IIx decoder is not available when Surround Back is set to “None” (see page 63).

■ Listening to high fidelity stereo sound (PURE DIRECT)

PURE DIRECT bypasses this unit's decoders and DSP processors as well as shuts down the video circuitry, allowing you to enjoy the highest possible sound fidelity from analog and PCM sources.

Press PURE DIRECT to activate pure direct.

The button lights up and the front panel display automatically goes out.



Front panel

or



Remote control



The front panel display switches on momentarily when an operation is performed.

To cancel, press PURE DIRECT again.

The indicator around the front panel button goes out and the previous settings are restored.

Notes

- To avoid unexpected noise, do not play DTS-encoded CDs in this mode.
- When a multi-channel signal (Dolby Digital or DTS) is input, this unit automatically switches to the corresponding analog input. (When DTS is selected as an input mode, no sound will be heard.)
- No sound will be output from the subwoofer.
- Tone Control (page 35) and GUI menu (page 52) settings are not effective.
- The following operations are not possible during PURE DIRECT operation:
 - switching the sound field program
 - displaying the short message
 - adjusting GUI menu parameters
 - all video functions (video conversion etc.)
- PURE DIRECT is automatically cancelled whenever this unit is set to the standby mode.

■ Night listening modes

The night listening modes are designed to improve listenability at lower volumes or at night. Choose either NIGHT:CINEMA or NIGHT:MUSIC depending on the type of material you are playing.

Set AMP/SOURCE/TV to AMP, then press NIGHT on the remote control repeatedly to select cinema or music.

When night listening is selected, the NIGHT indicator in the front panel display lights up.



Remote control

- Select NIGHT:CINEMA when watching films to reduce the dynamic range of film soundtracks and make dialog easier to hear at lower volumes.
- Select NIGHT:MUSIC when listening to music sources to preserve ease-of-listening for all sounds.
- Select NIGHT:OFF if you do not want to use this function.

Press ◀/▶ to adjust the effect level while NIGHT:CINEMA or NIGHT:MUSIC is displayed.

This adjusts the level of compression.

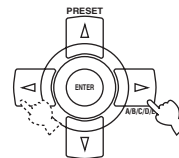

Remote control

Effect.Lvl:MID

- Select “MIN” for minimum compression.
- Select “MID” for standard compression.
- Select “MAX” for maximum compression.



NIGHT:CINEMA and NIGHT:MUSIC adjustments are stored independently.

Notes

- You cannot use the night listening modes with PURE DIRECT, MULTI CH INPUT, or when headphones are connected (even though the NIGHT indicator lights up when PURE DIRECT is selected).
- The night listening modes may vary in effectiveness depending on the input source and surround sound settings you use.

■ Downmixing to 2 channels

You can enjoy 2-channel stereo playback from multi-channel sources.

Rotate PROGRAM (or set AMP/SOURCE/TV to AMP, then press STEREO on the remote control) to select 2ch Stereo.

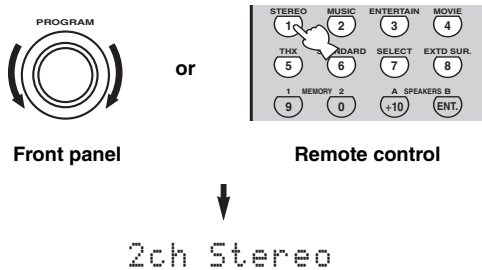

Note

You can use a subwoofer with this program when SWFR or BOTH is selected in LFE/BASS OUT.

■ Listening to unprocessed input signals

In STRAIGHT mode, two channel stereo sources are output from only the front left and right speakers. Multi-channel sources are decoded straight into the appropriate channels without any additional effect processing.

Press STRAIGHT (EFFECT) to select STRAIGHT.

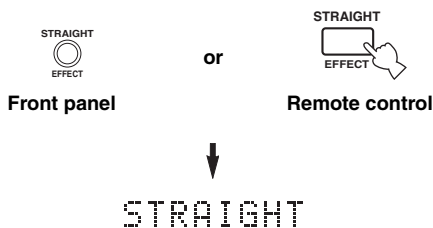

Press STRAIGHT/EFFECT again so that “STRAIGHT” disappears from the display when you want to turn the sound effect back on.

■ Virtual CINEMA DSP

Virtual CINEMA DSP allows you to enjoy the CINEMA DSP programs without surround speakers. It creates virtual speakers to reproduce a natural sound field. If you set Surround to None, Virtual CINEMA DSP activates automatically whenever you select a CINEMA DSP sound field program.

Note

Virtual CINEMA DSP will not activate, even when Surround is set to “None” (see page 62) in the following cases:

- When MULTI CH INPUT is selected as the input source.
- When headphones are connected to the PHONES jack.

■ Playing video sources in the background

You can combine images from a video source with sound from an audio source. For example, you can enjoy listening to classical music while having beautiful scenery from the video source on the video monitor.

Use the input selector buttons to select a video source, then select an audio source.

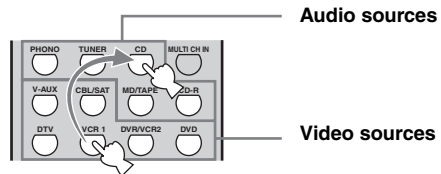

Note

If you want to enjoy an audio source connected to the MULTI CH INPUT jacks together with a video source, first select the video source and then press MULTI CH INPUT.

Selecting audio input modes

This unit comes with a variety of input jacks. You can select the type of input signal you want to use as follows.

Press **AUDIO SELECT** to select an input mode.

In most cases, use **AUTO**.

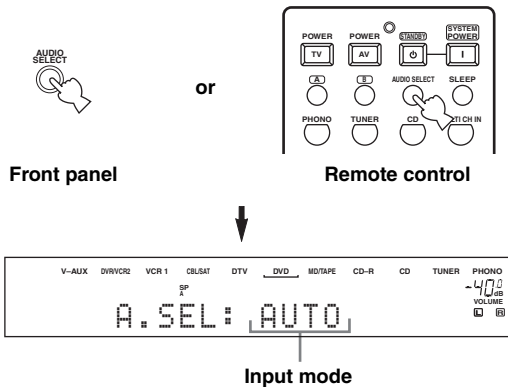

AUTO Automatically selects input signals in the following order:

- 1) i.LINK
- 2) HDMI
- 3) Digital signals*
- 4) Analog signals

i.LINK Selects only i.LINK signals.

If no i.LINK signals are input, no sound is output.

HDMI Selects only HDMI signals.

If no HDMI signals are input, no sound is output.

COAX/OPT Selects digital signals input at the OPTICAL or COAXIAL jacks. Use if i.LINK or HDMI signals are also being input.

ANALOG Selects only analog signals.

If no analog signals are input, no sound is output.

* If this unit detects a Dolby Digital or DTS signal, the decoder automatically switches to the appropriate sound field program.



- You can adjust the default input mode this unit selects when the power is turned on (see page 56).
- DTS mode is recommended for playback of a CD or LD encoded in DTS.

Note

If the digital output data of the player has been processed in any way, you may not be able to perform DTS decoding even if you make a digital connection between this unit and the player.

■ Displaying information about the input source

You can display the type, format and sampling frequency of the current input signal.

1 Set AMP/SOURCE/TV to AMP, then press TOP on the remote control.

The top display appears.

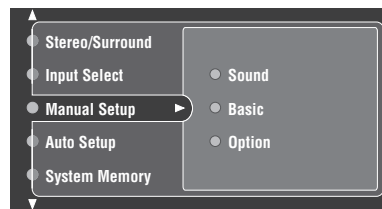

2 Press ∇ repeatedly to select Audio Info.

The following information appears in the display.

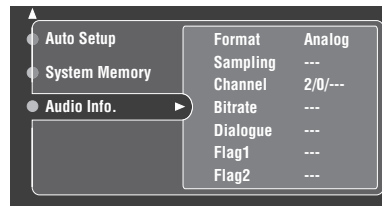

Format	Signal format display. When the unit cannot detect a digital signal it automatically switches to analog input.
Sampling	Sampling frequency. When the unit is unable to detect the sampling frequency “?” appears.
Channel	Number of source channels in the input signal. For example, a multi-channel soundtrack with 3 front channels, 2 surround channels and LFE, is displayed as “3/2/0.1”.
Bitrate	Bit rate. When the unit is unable to detect the bit rate “- - -” appears.
Dialogue	Dialogue normalization information for Dolby Digital signals.
Flag1/Flag2	Flag data encoded with DTS or Dolby Digital signals that cue this unit to automatically switch decoders.

3 Press EXIT.

TUNING

Automatic and manual tuning

There are 2 tuning methods: automatic and manual. Automatic tuning is effective when station signals are strong and there is no interference.

Automatic tuning

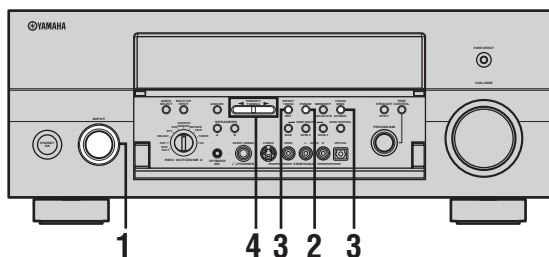

- 1 Rotate the INPUT selector to select TUNER as the input source.



- 2 Press FM/AM to select the reception band. "FM" or "AM" appears on the front panel display.



- 3 Press TUNING MODE (AUTO/MAN'L) so that the AUTO indicator lights up on the front panel display.



If a colon (:) appears in the front panel display, this unit is in PRESET mode and tuning is not possible. Press PRESET/TUNING (EDIT) to turn it off.

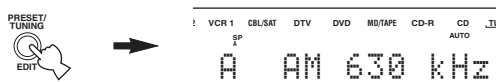

- 4 Press PRESET/TUNING </> once to begin automatic tuning.

Press > to tune into a higher frequency, or press < to tune into a lower frequency.

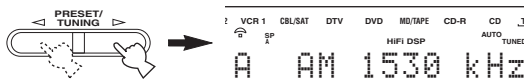

When tuned into a station, the TUNED indicator lights up and the frequency of the received station is shown on the front panel display.

Manual tuning

If the signal from the station you want to select is weak, you must tune into it manually. Manually tuning into an FM station will automatically change the reception mode to monaural reception to increase the signal quality.

- 1 Select TUNER and the reception band following steps 1 and 2 as described in "Automatic tuning".

- 2 Press TUNING MODE (AUTO/MAN'L) so that the AUTO indicator disappears from the front panel display.



If a colon (:) appears in the front panel display, this unit is in PRESET mode and tuning is not possible. Press PRESET/TUNING (EDIT) to turn it off.

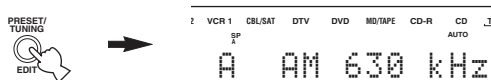

- 3 Press PRESET/TUNING </> to tune into the desired station manually.

Hold down the button to continue searching.

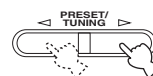

Presetting stations

■ Automatically presetting FM stations

You can use the automatic preset tuning feature to store FM stations. This function enables this unit to automatically tune into FM stations with strong signals, and to store up to 40 (8 stations in 5 groups, A1 through E8) of those stations in order. You can then recall any preset station easily by selecting the preset station number.

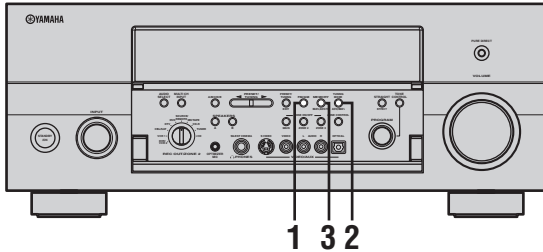

1 Press FM/AM to select the FM band.



2 Press TUNING MODE (AUTO/MAN'L) so that the AUTO indicator lights up on the front panel display.



3 Press and hold MEMORY (MAN'L/AUTO FM) for more than 3 seconds.

The preset number, the MEMORY and AUTO indicators flash. After about 5 seconds, automatic presetting starts from the frequency currently displayed and proceeds toward the higher frequencies.



When automatic preset tuning is completed, the front panel display shows the frequency of the last preset station.

Notes

- Any stored station data existing under a preset number is cleared when you store a new station under that preset number.
- If the number of the received stations does not reach 40 (E8), automatic preset tuning has automatically stopped after searching all stations.
- Only FM stations with sufficient signal strength are stored automatically by automatic preset tuning. If the station you want to store is weak in signal strength, tune into it manually and store it by following the procedure in “Manually presetting stations”.

Automatic preset tuning options

You can select the preset number from which this unit will store FM stations and/or begin tuning toward lower frequencies.

After pressing MEMORY in step 3:

- 1 Press A/B/C/D/E, then PRESET/TUNING </> to select the preset number under which the first station will be stored. Automatic preset tuning will stop when stations have all been stored up to E8.
- 2 Press PRESET/TUNING (EDIT) to turn off the colon (:), and then press PRESET/TUNING </> to begin tuning toward lower frequencies.

Memory back-up

The memory back-up circuit prevents the stored data from being lost even if this unit is set in the standby mode, the power cable is disconnected from the AC outlet, or the power supply is temporarily cut due to power failure. However, if the power is cut for more than one week, the preset stations may be cleared. If so, store the stations again by using the presetting station methods.

Manually presetting stations

You can also store up to 40 FM or AM stations (8 stations in 5 groups, A1 through E8) manually.

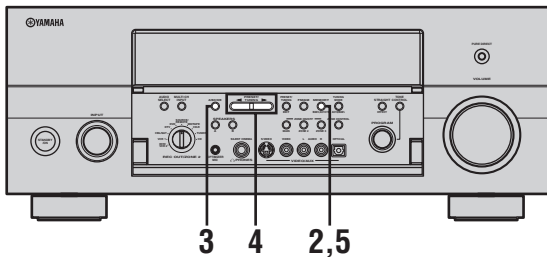

1 Tune into a station.

See page 41 for tuning instructions.

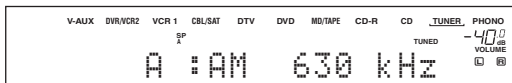

When tuned into a station, the front panel display shows the frequency of the station received.

2 Press MEMORY (MAN'L/AUTO FM).

The MEMORY indicator flashes for about 5 seconds.



3 Press A/B/C/D/E repeatedly to select a preset station group (A to E) while the MEMORY indicator is flashing.

The group letter appears. Check that the colon (:) appears on the front panel display.

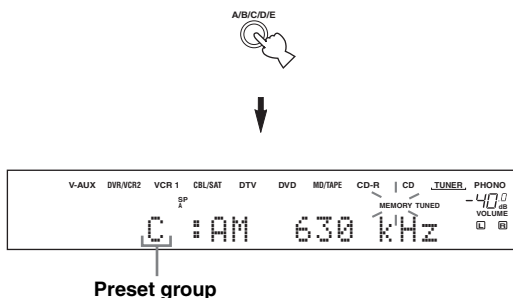

4 Press PRESET/TUNING </> to select a preset station number (1 to 8) while the MEMORY indicator is flashing.

Press > to select a higher preset station number.
Press < to select a lower preset station number.

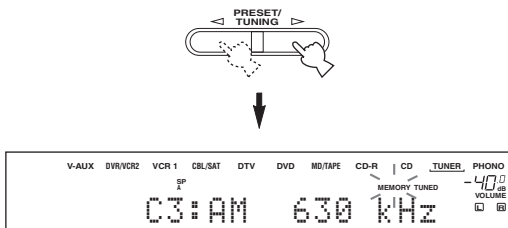

5 Press MEMORY (MAN'L/AUTO FM) on the front panel while the MEMORY indicator is flashing.

The station band and frequency appear in the front panel display with the preset group and number you have selected.

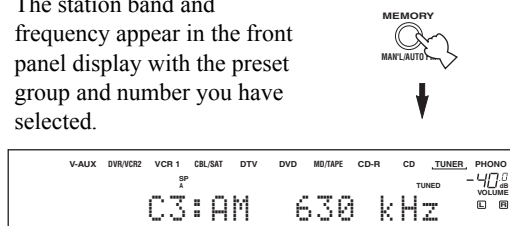

Shows the displayed station has been stored as C3.

6 Repeat steps 1 to 5 to store other stations.

Notes

- Any stored station data existing under a preset number is cleared when you store a new station under that preset number.
- The reception mode (stereo or monaural) is stored along with the station frequency.

Selecting preset stations

You can tune any desired station simply by selecting the preset station number under which it was stored.

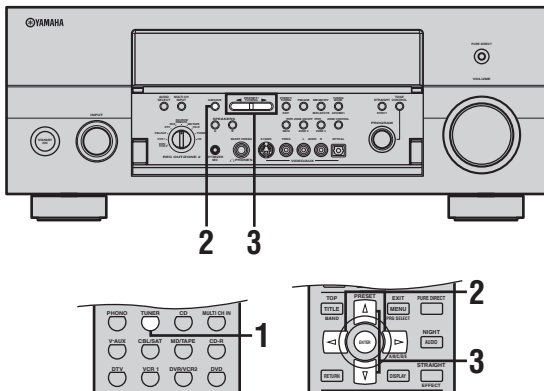

- 1 Set AMP/SOURCE/TV to SOURCE, then press TUNER to set the remote to tuner mode.
- 2 Press A/B/C/D/E (or </> on the remote control) to select the preset station group. The preset group letter appears on the front panel display and changes each time you press the button.

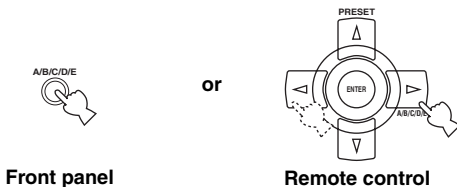

Front panel

Remote control

- 3 Press PRESET/TUNING </> (or PRESET Δ / ∇ on the remote control) to select a preset station number (1 through 8). The preset group and number appear on the front panel display along with the station band, frequency and the TUNED indicator lights up.

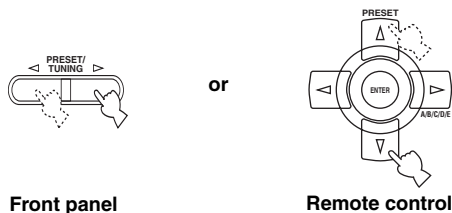

Front panel

Remote control

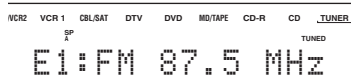

Exchanging preset stations

You can exchange the assignment of two preset stations with each other. The example below describes the procedure for exchanging preset station "E1" with "A5".

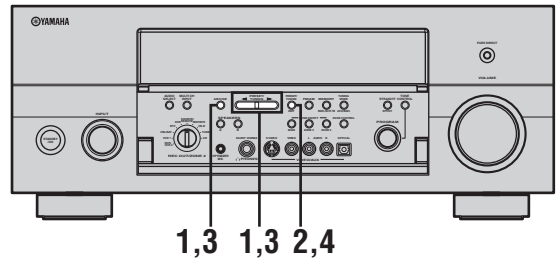

- 1 Select preset station "E1" by using A/B/C/D/E and PRESET/TUNING </>. See "Selecting preset stations".
- 2 Press and hold PRESET/TUNING (EDIT) for more than 3 seconds. "E1" and the MEMORY indicator flash in the front panel display.

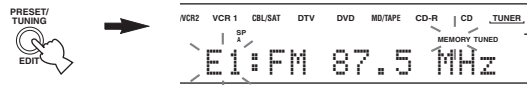

- 3 Select preset station "A5" by using A/B/C/D/E and PRESET/TUNING </>. "A5" and the MEMORY indicator flash in the front panel display.

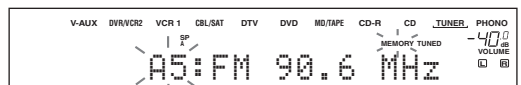

- 4 Press PRESET/TUNING (EDIT) again. The stations stored at the two preset assignments are exchanged.

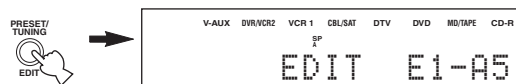

Using HD Radio™

HD Radio is a new technology that enables AM and FM radio stations to broadcast programs digitally. Digital broadcasting provides listeners with radically improved audio quality and reception as well as new data services. Furthermore, supplemental program services allow listeners to select from up to 8 HD Radio programs multicast on a single FM HD Radio channel. For further information on HD Radio, visit “www.iberquity.com”.

This unit is equipped with an HD Radio reception feature, facilitating CD quality FM broadcasts as well as analog FM stereo quality AM broadcasts. In addition, this unit can receive both audio and data (such as song titles, artist names, album names, and genres) from supplemental program services (HD1 to HD8).

HD Radio™ tuning

Just as for tuning into an analog FM or AM station, 2 tuning methods are available: automatic and manual.

CAUTION

This unit is capable of receiving both hybrid and all-digital HD Radio station signals. However, this unit may not automatically receive all-digital FM station signals and the automatic tuning operation may stop. In this case, select one of the preset stations, or manually tune into the FM station you want to select, then set the tuning mode back to AUTO by pressing TUNING MODE (AUTO/MAN'L).

■ HD Radio automatic tuning

Automatic tuning is effective when station signals are strong and there is no interference.

Follow steps 1 through 4 as described in “Automatic tuning” on page 41.

Both analog and digital broadcasts are received, but when tuned into an HD Radio station, the TUNED and HD indicators light up and the frequency of the received station is displayed in the front panel.

If the HD indicator lights up, the broadcast being received contains an HD Radio digital signal.

■ HD Radio manual tuning

Manual tuning is recommended when station signals are weak.

Follow steps 1 through 3 as described in “Manual tuning” on page 41, then set the tuning mode back to AUTO by pressing TUNING MODE (AUTO/MAN'L).

Both analog and digital broadcasts are received, but when tuned into an HD Radio station, the TUNED and HD indicators light up and the frequency of the received station is displayed in the front panel.

Note

If station signals are weak, analog broadcasts will be played back instead even in the automatic tuning mode, and the HD indicator does not light up.

Selecting HD Radio™ audio programs

Use this feature to select one of the 8 HD Radio audio programs (HD1 to HD8) when the unit is in the tuner mode. Each audio program contains data programs.

Press PRG SELECT on the remote control repeatedly to toggle between HD Radio audio programs.

Press PRG SELECT again within 2 seconds to select another data program.

The HD indicator may disappear from the front panel display while toggling between data programs.

Notes

- Only 1 HD Radio audio program (HD1) is available for AM broadcasts, while up to 8 audio programs (HD1 to HD8) are available for FM broadcasts.
- When reception for an audio program ceases, the HD indicator disappears from the front panel display and HD1 is automatically selected after approximately 20 seconds.
- Some audio programs may not contain data programs depending on the broadcasting station and the time period.
- The audio programs from HD2 to HD8 can be selected only when they contain data programs.

Displaying HD Radio™ information

There are 3 types of front panel displays that show HD Radio information when the unit is in the tuner mode: frequency, station and music information.

Press DISPLAY on the remote control repeatedly to toggle between the following 3 front panel displays.

■ Frequency information

(Preset group / FM or AM / Frequency)



■ Station information

(Station name / FM or AM / Audio program)

Station information is available when a station name is received as data in 4 alphabetical codes.



■ Music information

(Song title / Artist name / Album name / Genre)

Music information is available only when data programs are received.

If the music information is long, it automatically scrolls to the left in the front panel display.



HD Radio information is also available in the GUI menu (see page 55).

RECORDING

You can use the REC OUT/ZONE 2 control to record one source while watching and/or listening to another source.

Recording adjustments and other operations are performed from the recording components. Refer to the operation instructions for those components.

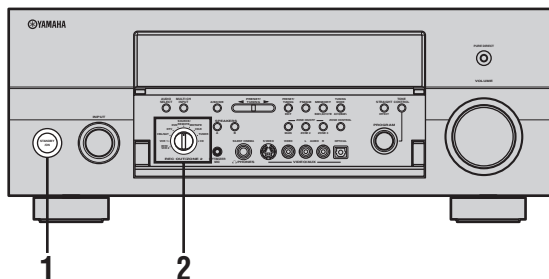

1 Turn on the power of this unit and all connected components.

2 Select the source component you want to record from by using REC OUT/ZONE 2.

- To record the current input source that you are watching or listening to, set REC OUT/ZONE 2 to SOURCE/REMOTE.

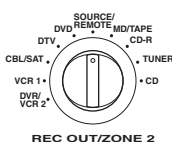

- To record a source other than the one that you are watching or listening to, set REC OUT/ZONE 2 to the source you want to record.

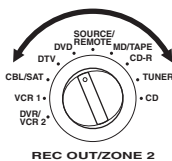

After this setting, you can change the source you are listening to and/or watching without effecting the recording by rotating the INPUT selector (or pressing one of the input selector buttons on the remote control).

3 Start playback (or select a broadcast station) on the source component.

4 Start recording on the recording component.



- To record audio and video from different sources, set REC OUT/ZONE 2 to SOURCE/REMOTE, select a video source first then select an audio source (see page 39).
- Do a test recording before you start an actual recording.

Notes

- The source you record and the source sent to Zone 2 are always the same.
- When this unit is set in the standby mode, you cannot record between other components connected to this unit.
- The setting of TONE CONTROL, (see page 60) VOLUME, Speaker Level (page 65) and programs does not affect recorded material.
- A source connected to the MULTI CH INPUT jacks of this unit cannot be recorded.
- S-video and composite video signals pass independently through this unit's video circuits. Therefore, when recording or dubbing video signals, if your video source component is connected to provide only an S-video (or only a composite video) signal, you can record only an S-video (or only a composite video) signal to your VCR.
- Digital signals input at the DIGITAL INPUT jacks are not output at the analog AUDIO OUT (L/R) jacks for recording. Likewise, analog signals input at the AUDIO IN (L/R) jacks are not output at the DIGITAL OUTPUT jack. Therefore, if your source component is connected to provide only digital (or analog) signals, you can only record digital (or analog) signals.
- A given input source is not output on the same REC OUT channel. (For example, the signal input from VCR 1 IN is not output on VCR 1 OUT.)
- Check the copyright laws in your country to record from records, CDs, radio, etc. Recording of copyrighted material may infringe copyright laws.
- Audio signals input from the selected i.LINK or HDMI components are output to REC OUT when REC OUT/ZONE 2 on the front panel is set to SOURCE/REMOTE or to the source you want to record. However, multi-channel DVD audio signals, DSD signals of Super Audio CD and 2-channel PCM signals over 48 kHz of sampling frequency cannot be output to REC OUT.

If you play back a video source that uses scrambled or encoded signals to prevent it from being dubbed, the picture itself may be disturbed due to those signals.

Special considerations when recording DTS software

The DTS signal is a digital bitstream. Attempting to digitally record the DTS bitstream will result in noise being recorded. Therefore, if you want to use this unit to record sources that have DTS signals recorded on them, the following considerations and adjustments need to be made.

For DVDs and CDs encoded with DTS, when your player is compatible with the DTS format, follow its operation instruction to make a setting so that the analog signal will be output from the player.

SOUND FIELD PROGRAM DESCRIPTIONS

This unit is equipped with a variety of precise digital decoders that allow you to enjoy multi-channel playback from almost any sound source (stereo or multi-channel). This unit is also equipped with a YAMAHA digital sound field processing (DSP) chip containing several sound field programs which you can use to enhance your playback experience. Most of these sound field programs are precise digital recreations of actual acoustic environments found in famous concert halls, music venues, and movie theaters.



The YAMAHA CINEMA DSP modes are compatible with all Dolby Digital, DTS, and Dolby Surround sources. Set the input mode to AUTO (see page 40) to enable this unit to automatically switch to the appropriate digital decoder according to the input signal.

Notes

- This unit's DSP sound field programs are recreations of real-world acoustic environments made from precise measurements taken in actual halls, etc. Thus you may notice variations in the strength of the reflections coming from the front, back, left and right.
- Feel free to choose a sound field program based on your listening preference, and not purely on the name of the program itself.

For movie/video sources

You can select from the following sound fields when playing movie or video sources. The sound fields marked "MULTI" can be used with multi-channel sources, like DVD, digital TV, etc. Those marked "2-CH" can be used with 2-channel (stereo) sources like TV programs, video tapes, etc.

Program selection methods vary depending on sound field program types. For details on how to select sound field programs, see "Selecting sound field programs" on pages 34 and 35.

Sources	Remote control button	Program	Features
MULTI 2-CH	1	STEREO 2ch Stereo	Downmixes multi-channel sources to 2 (left and right) channels or plays back 2-channel sources as is.
	3	ENTERTAINMENT TV Sports	CINEMA DSP processing. Though the presence sound field is relatively narrow, the surround sound field employs the sound environment of a large concert hall. This effect enhances the experience of watching various TV programs such as news, variety shows, music programs or sports programs.
		ENTERTAINMENT Mono Movie	CINEMA DSP processing. This program is provided for reproducing monaural video sources (such as old movies). The program produces the optimum reverberation to create sound depth using only the presence sound field.
		ENTERTAINMENT Game	CINEMA DSP processing. This program adds a deep and spatial feeling to video game sounds.
	4	MOVIE THEATER Spectacle	CINEMA DSP processing. This program creates the extremely wide sound field of a 70-mm movie theater. It precisely reproduces the source sound in detail, making both the video and the sound field incredibly real. This is ideal for any kind of video source encoded with Dolby Surround, Dolby Digital or DTS (especially large-scale movie productions).
		MOVIE THEATER Sci-Fi	CINEMA DSP processing. This program clearly reproduces dialog and sound effects in the latest sound form for science fiction films, thus creating a broad and expansive cinematic space amid silence. You can enjoy science fiction films in a virtual-space sound field that includes Dolby Surround, Dolby Digital and DTS-encoded software employing the most advanced techniques.
		MOVIE THEATER Adventure	CINEMA DSP processing. This program is ideal for precisely reproducing the sound design of the newest 70-mm and multichannel soundtrack films. The sound field is made to be similar to that of the newest movie theaters, so the reverberations of the sound field itself are restrained as much as possible.
		MOVIE THEATER General	CINEMA DSP processing. This program is for reproducing sounds from 70-mm and multichannel soundtrack films, and is characterized by soft and extensive sound field. The presence sound field is relatively narrow. It spatially spreads all around and toward the screen, restraining the echo effect of conversations without losing clarity.

Sources	Remote control button	Program	Features	
MULTI 2-CH	5	THX THX Cinema	THX processing for movie software.	
		THX THX Game	THX processing for game software.	
		THX THX Select2 Cinema	THX Select2 processing for movie software.	
MULTI	6	THX THX Surr. EX	THX processing for any 5.1 channel source.	
		SUR. STANDARD DOLBY DIGITAL	Standard 5.1 channel processing for Dolby Digital sources.	
		SUR. STANDARD DOLBY DIGITAL D+PLIIx Movie	Standard 7.1 channel processing for Dolby Digital sources.	
		SUR. STANDARD DOLBY D EX	Standard 6.1 channel processing for Dolby Digital sources.	
	SUR. STANDARD DTS	Standard 5.1 channel processing for DTS sources.		
	SUR. STANDARD DTS 96/24	Standard 5.1 channel processing for 96kHz/24-bit DTS sources.		
	SUR. STANDARD DTS+PLIIx Movie	Standard 7.1 channel processing (Dolby Pro Logic IIx) for DTS sources.		
	SUR. STANDARD DTS+DOLBY EX	Standard 6.1 channel processing (Dolby Digital EX) for DTS sources.		
	SUR. STANDARD DTS ES	Standard 6.1 channel processing (DTS-ES Matrix and DTS-ES Discrete) for DTS sources.		
	SUR. STANDARD DTS 96/24 ES	Standard 6.1 channel processing (DTS-ES Matrix and DTS-ES Discrete) for 96kHz/24-bit DTS sources.		
	SUR. ENHANCED	CINEMA DSP enhanced processing for the selected decoder.		
	2-CH		SUR. STANDARD PRO LOGIC	Standard processing for Dolby Surround sources.
			SUR. STANDARD PLIIx Movie	Dolby Pro Logic IIx processing for movie software.
SUR. STANDARD PLII Movie			Dolby Pro Logic II processing for movie software.	
SUR. STANDARD PLIIx Game			Dolby Pro Logic IIx processing for game software.	
SUR. STANDARD PLII Game			Dolby Pro Logic II processing for game software.	
SUR. STANDARD Neo:6 Cinema			DTS processing for movie software.	
SUR. STANDARD CS II Cinema			SRS Circle Surround II processing for movie software. (U.S.A. model only)	
SUR. ENHANCED	CINEMA DSP enhanced processing for the selected decoder.			

For music sources

You can select from the following sound fields when playing music sources, like CD, FM/AM broadcasting, tapes, etc.

Program selection methods vary depending on sound field program types. For details on how to select sound field programs, see “Selecting sound field programs” on pages 34 and 35.

Sources	Remote control button	Program	Features
MULTI 2-CH	1	STEREO 2ch Stereo	2 channel (left and right) playback.
		STEREO 7ch Stereo	HiFi DSP processing. Use to increase the output stereo sources (in stereo) from all speakers. This provides a larger sound field and is ideal for background music at parties, etc.
	2	MUSIC Hall in Munich	HiFi DSP processing. This is a large fan-shaped concert hall which has approximately 2500 seats. Almost the whole interior is made of wood. There is relatively little reflection from the walls, and sound spreads finely and beautifully.
		MUSIC Hall in Vienna	HiFi DSP processing. A classic shoe-box type concert hall with approximately 1700 seats. Pillars and ornate carvings create extremely complex reflections which produce a very full, rich sound.
		MUSIC Freiburg	HiFi DSP processing. This program recreates the acoustic environment of a big church with a high dome and columns along each side. The reverberation delay is very long while the early reflections are smaller than with other sound field programs.
		MUSIC The Btm Line	HiFi DSP processing. This is the sound field at stage front in “The Bottom Line”, a famous New York jazz club. The floor can seat 300 people to the left and right in a sound field offering real and vibrant sound.
		MUSIC The Roxy Thtr	HiFi DSP processing. The ideal program for lively, dynamic rock music. The data for this program was recorded at LA’s “hottest” rock club. The listener’s virtual seat is at the center-left of the hall.
		MUSIC Pop/Rock	CINEMA DSP processing. This program produces a vibrant atmosphere and lets you feel as if you are at an actual jazz or rock concert.
	3	MUSIC Classic/Opera	CINEMA DSP processing. This program provides excellent vocal depth and overall clarity by restraining excessive reverberation. The surround sound field is relatively moderate but it reproduces beautiful sound using data collected from a concert hall.
		5	ENTERTAINMENT Disco
MULTI	5	THX THX Music	THX processing for all 5.1 encoded music sources.
		SUR. STANDARD D+PLIIx Music	Standard Dolby Digital and Dolby Pro Logic IIx processing for music sources.
		SUR. STANDARD DTS+PLIIx Music	Standard DTS and Dolby Pro Logic IIx processing for music sources.
2-CH	6	SUR. ENHANCED	CINEMA DSP enhanced processing for the selected decoder.
		SUR. STANDARD PLIIx Music	Dolby Pro Logic IIx processing for music software.
		SUR. STANDARD PLII Music	Dolby Pro Logic II processing for music software.
		SUR. STANDARD Neo:6 Music	DTS processing for music software.
2-CH	6	SUR. STANDARD CS II Music	SRS Circle Surround II processing for music software. (U.S.A. model only)

ADVANCED OPERATIONS

Using the sleep timer

Use this feature to automatically set this unit in the standby mode after a certain amount of time. The sleep timer is useful when you are going to sleep while this unit is playing or recording a source. The sleep timer also automatically turns off any external components connected to the AC OUTLET(S).

■ Setting the sleep timer

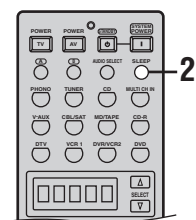

■ Canceling the sleep timer

Press SLEEP repeatedly until “SLEEP OFF” appears on the front panel display.

After a few seconds, “SLEEP OFF” disappears, and the SLEEP indicator goes off.



The sleep timer setting can also be canceled by pressing STANDBY on the remote control (or STANDBY/ON on the front panel) to set this unit to the standby mode.

1 Select a source and start playback on the source component.

2 Press SLEEP repeatedly to set the amount of time.

Each time you press SLEEP, the front panel display changes as shown below. The SLEEP indicator flashes while switching the amount of time for the sleep timer.



→ SLEEP 120 min → SLEEP 90 min
 SLEEP OFF ← SLEEP 30 min ← SLEEP 60 min ←

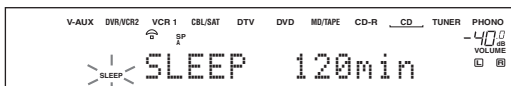

The SLEEP indicator lights up in the front panel display, and the display returns to the selected sound field program.

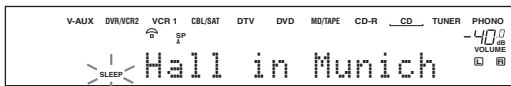

SYSTEM OPTIONS

You can use the following parameters to adjust a variety of system settings and customize the way this unit operates. Change the initial settings (indicated in bold under each parameter) to reflect the needs of your listening environment.

■ HDMI (HDMI menu)

Use to edit HDMI parameters (see page 95).

■ i.LINK Select (i.LINK select menu)

Use to edit i.LINK parameters (see page 91).

■ Stereo/Surround (Stereo/Surround menu)

Use to edit sound field parameters (see page 99).

■ Input Select (Input select menu)

Use to reassign digital input/outputs, select the input signal, rename the inputs, or adjust the output volume of each jack (see page 55).

Item	Features	Page
I/O Assignment	Assigns jacks according to the component to be used.	55
Audio Select	Selects the type of input signal to be used.	56
Decoder Mode	Selects the input mode for sources connected to the DIGITAL INPUT jacks.	56
Volume Trim	Adjusts the output volume of each jack.	56
Rename	Changes the name of the input.	57

■ Manual Setup (Manual setup menu)

Use to manually adjust speaker and system settings (see page 58).

Sound (Sound menu)

Use to manually adjust the sound parameters.

Item	Features	Page
LFE Level	Adjusts the output level of the LFE channel for Dolby Digital or DTS signals.	58
Dynamic Range	Adjusts the dynamic range for Dolby Digital or DTS signals.	58
Parametric EQ	Adjusts the tonal quality of each speaker.	59
Tone Control	Adjusts the tonal balance of the speakers and headphones.	60
Audio Option	Customizes overall audio settings for this unit.	60

Basic (Basic menu)

Use to quickly setup basic system parameters.

Item	Features	Page
Test Tone	Turns the test tone output on or off for Speaker Set, Speaker Distance and Speaker Level settings.	62
Speaker Set	Selects the output mode suitable for each speaker, the speakers for low-frequency signal output, and the cross over frequency.	62
Speaker Distance	Adjusts the delay time of each speaker.	64
Speaker Level	Adjusts the output level of each speaker.	65
THX Set	Adjusts the THX settings.	65

Option (Options menu)

Use to adjust the optional system settings.

Item	Features	Page
Display	Adjusts the GUI and front panel displays.	66
Multi Zone	Customizes the Zone 2, Zone 3 and Zone B settings.	67
Sur.Initialize	Initializes the parameters of all or a group of sound field programs.	67
Audio Select	Selects the initial input mode of the source.	68
Decoder Mode	Selects the decoder used by this unit.	68
Memory Guard	Locks the menu parameter settings.	68

■ **Auto Setup (Auto setup menu)**

Use to specify which speaker parameters auto setup will adjust, and to activate the auto setup procedure (see page 27).

■ **System Memory (System memory menu)**

Use to save and recall various settings (see page 69).

■ **Audio Info. (Audio signal information menu)**

Use to check audio signal information (see page 40).

Changing parameter settings

Use the remote control to access and adjust each parameter. (Speaker set is used in the following example to change parameter settings.)

Manual Setup > Basic > Speaker Set >

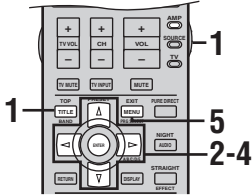

- 1 Set AMP/SOURCE/TV to AMP, then press TOP on the remote control.

The top display appears.

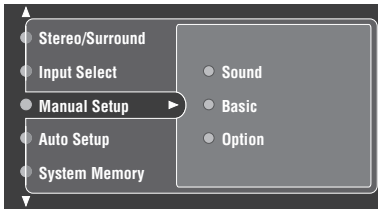

- 2 Press Δ / ∇ repeatedly to select a menu, then press \triangleright to enter the selected menu.

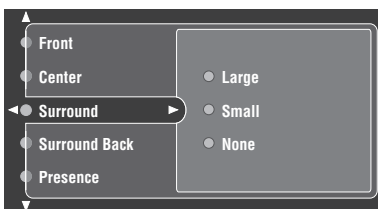
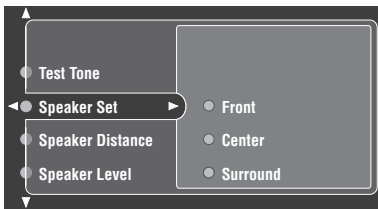

- 3 Press Δ / ∇ repeatedly to select the parameter you want to adjust.

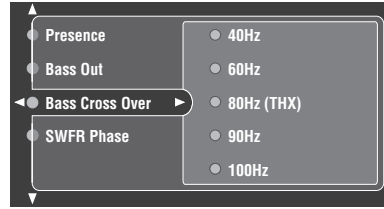

- 4 Press ENTER or \triangleright , then press Δ / ∇ repeatedly to change the setting of the item you want to adjust.

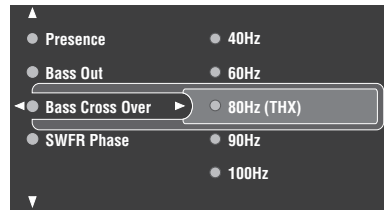

- 5 Press EXIT.



If you want to continue adjusting parameter settings, press ENTER to return to the previously selected menu item.

Notes

- The available parameters may be displayed on more than one page of the GUI display. To scroll through pages, press Δ / ∇ .
- You cannot change parameter values when Memory Guard is set to "On". If you want to change the parameter values, set Memory Guard to "Off" (see page 68).

Memory back-up

The memory back-up circuit prevents the stored data from being lost even if this unit is set in the standby mode, the power cable is disconnected from the AC outlet, or the power supply is temporarily cut due to power failure. However, if the power is cut for more than one week, the parameter values will return to the factory settings. If this happens, edit the parameter value again.

Input Select

Use this feature to reassign digital input/outputs, select the input signal, rename the inputs, or adjust the level of the signal input at each jack.

- 1 Set AMP/SOURCE/TV to AMP, then press **TOP** on the remote control.

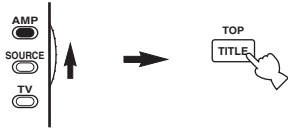

- 2 Select Input Select, then press **▷**.

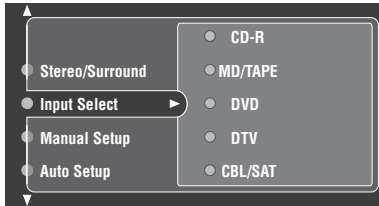

- 3 Select the desired input (CD, DVD, etc.), then press **▷** to access and adjust.

Information (Information)

There are 2 types of GUI displays that show HD Radio information when the unit is in the tuner mode: station and music information.

Input Select > TUNER > Information >

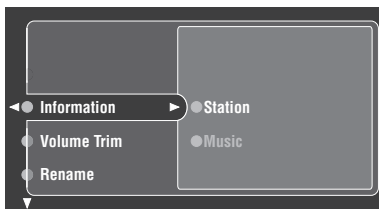

Station information

(Band / Frequency / Station name / Program / Program type)

Station information is available when a station name is received as data in 4 alphabetical codes.

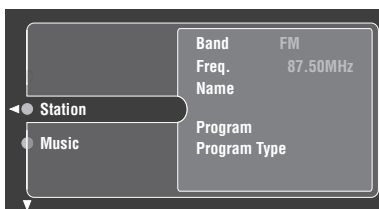

Music information

Page 1: the summary of music information

(Song title / Artist name / Album name)

Page 2: the details of the song title

Page 3: the details of the artist

Page 4: the details of the album

Page 5: the details of the genre

Press **◀** / **▶** repeatedly to toggle between pages.

Press **ENTER** on the remote control to hold the display temporarily. "Hold:ENTER" changes to

"Release:ENTER". Press **ENTER** again to release it.

Music information is available only when data programs are received.

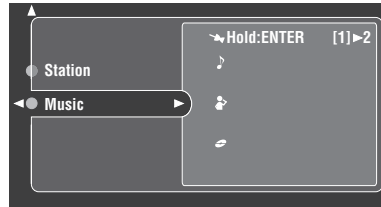

HD Radio information is also available in the front panel display menu (see page 46).

I/O Assignment (Input/output assignment)

You can assign the digital audio input/output and component video jacks to other components if this unit's initial settings do not correspond to your needs. Change the following parameters to reassign the jacks and effectively connect more components.

Once the jacks are reassigned, you can select the corresponding component using the INPUT selector on the front panel or the input selector buttons on the remote control.

Input Select > input source (DVD, etc.) >

I/O Assignment >

Example 1:

To assign the COAXIAL ⑦ (CD) jack to the DVD input.

1) Select Input Select, then select DVD.

2) Select I/O Assignment > Coaxial Input, then select

⑦ CD.

Example 2:

To clear a jack assignment.

- 1) Select Input Select, then select the input source (DVD, etc.).
- 2) Select I/O Assignment, then select the jack assignment (Optical Output, Optical Input, Coaxial Input or Component Video).
- 3) Select NONE, then press ENTER to clear the assignment.

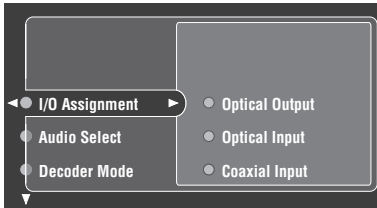

This menu item is also available in the front panel display system options menu (see page 89).

Notes

- You cannot select a specific item more than once for the same type of jack.
- When you connect a component to both the COAXIAL and OPTICAL jacks, priority is given to signals input at the COAXIAL jack.

Audio Select (Audio selection)

This unit comes with a variety of input jacks. You can select the type of input signal you want to use.

Input Select > input source (DVD, etc.) > Audio Select >

Choices: **Auto**, i.LINK, HDMI, Coax/Opt, Analog

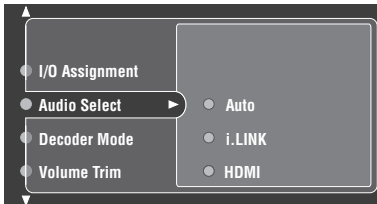

- Select “Auto” if you want signals to be input to this unit in the following order: i.LINK signals, HDMI signals, digital signals* and analog signals.
- Select “i.LINK” if you only want i.LINK signals to be input to this unit. If no i.LINK signals are input, no sound is output.
- Select “HDMI” if you only want HDMI signals to be input to this unit. If no HDMI signals are input, no sound is output.
- Select “Coax/Opt” if you want digital signals to be input to this unit at the OPTICAL or COAXIAL jacks. Use if i.LINK or HDMI signals are also being input.
- Select “Analog” if you only want analog signals to be input to this unit. If no analog signals are input, no sound is output.

* If this unit detects a Dolby Digital or DTS signal, the decoder automatically switches to the appropriate sound field program.



- You can adjust the default input mode this unit selects when the power is turned on (see page 68).
- DTS mode is recommended for playback of a CD or LD encoded in DTS.

Note

If the digital output data of the player has been processed in any way, you may not be able to perform DTS decoding even if you make a digital connection between this unit and the player.

Decoder Mode (Decoder mode)

Use this feature to switch the input mode. You can designate the reassigned digital input jacks (see page 55) for specific audio signals (DTS, etc.).

Input Select > input source (DVD, etc.) >

Decoder Mode >

Choices: **Auto**, DTS

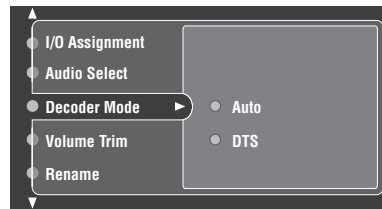

- Select “Auto” if you want this unit to automatically detect input signal types and select the appropriate input mode.
- Select “DTS” if you want this unit to select DTS as the input mode.



This menu item is also available in the front panel display system options menu (see page 89).

Volume Trim (Volume trimming)

You can adjust the level of the signal input at each jack. This is useful if you want to balance the level of each input source to avoid sudden changes in volume when switching between input sources.

Manual Setup > Input Select > input source (DVD, etc.) > Volume Trim >

Control range: -6.0 dB to +6.0 dB

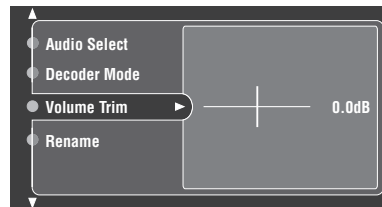

This menu item is also available in the front panel display system options menu (see page 89).

Note

You can only adjust the volume for the current input source using this setting.

■ Rename (Rename)

Use this feature to change the name of the inputs in the GUI or the front panel display menu. (DVD is used as the source component in the following example.)

Input Select > input source (DVD, etc.) > Rename

1 Press an input selector button to select the input you want to change the name of.

2 Press \triangleleft / \triangleright to place the _ (under-bar) under the space or character you want to edit.

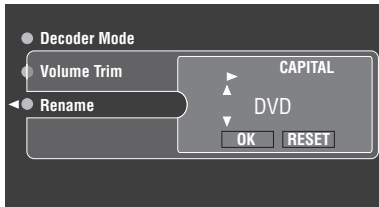

3 Press ENTER to select a character type (CAPITAL/SMALL/FIGURE/MARK).

4 Press \triangleup / \triangledown to select the character you want to use and \triangleleft / \triangleright to move to the next one.

- You can use up to 8 characters for each input.
- Press \triangledown to change the character in the following order, or press \triangleup to go in the reverse order. Press ENTER to switch between character types:
 - CAPITAL A to Z, space
 - SMALL a to z, space
 - FIGURE 0 to 9, space
 - MARK !, #, %, &, etc.
- Repeat steps 1 to 3 to rename each input.

5 Press \triangleleft / \triangleright to select OK and press ENTER when complete.



- To change source names in the display window on the remote control, see page 75.
- This menu item is also available in the changing source names in the display window feature (see page 75), and in the front panel display system options menu (see page 89).

Note

You can only change the name of the current input source (except for multi channel input sources) using this setting.

■ Multi CH Assign (Multi channel assignment)

Use this feature to set the direction of the signals input into the center, subwoofer and surround channels when a source component is connected to the MULTI CH INPUT jacks. If you are inputting 8-channel signals from an external decoder, use this feature to select jacks for the additional front signals.

Input Select > MULTI CH > Multi CH Assign >

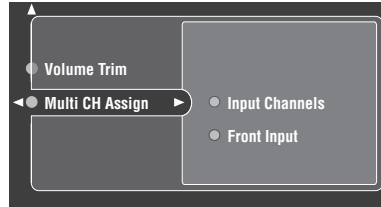

Input Channels

This setting is used to select the number of channels input from an external decoder.

Choices: 6ch, 8ch

Note

If Zone2 Amplifier (page 67) is set to “Internal”, no sound is output from the surround back speakers even if you select “8ch”. In this case, select “6ch” and set the output setting of the external component to 6 channels.

Front Input

If you selected “8ch” in Input Channels, you can select analog jacks at which front signals from an external decoder will be input.

Choices: DVD, DTV, CBL/SAT, VCR1, DVR/VCR2, V-AUX, CD, CD-R, MD/TAPE



This menu item is also available in the front panel display system options menu (see page 89).

Manual Setup (Sound)

Use this menu to adjust the sound parameters.

- 1 Set AMP/SOURCE/TV to AMP, then press TOP on the remote control.



- 2 Select Manual Setup, then press ▷.

- 3 Select Sound, then press ▷.

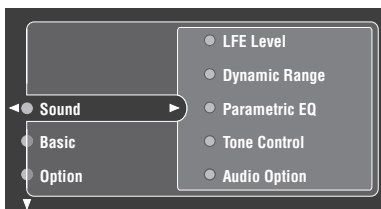

- 4 Select the desired parameters, then press ▷ to access and adjust.

■ LFE Level (Low-frequency effect level)

Use to adjust the output level of the LFE (low-frequency effect) channel according to the capacity of your subwoofer or headphones. The LFE channel carries low-frequency special effects which are only added to certain scenes. This setting is effective only when this unit decodes Dolby Digital or DTS signals.

To access these parameters, select:

Manual Setup > Sound > LFE Level >

Choices: -20.0 to **0.0** (dB)

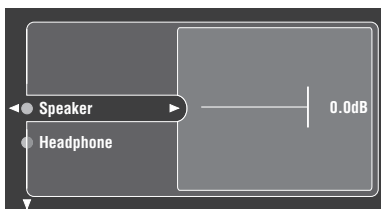

Speaker (Speaker low-frequency effect level)

Select to adjust the speaker LFE level.

Headphone (Headphone low-frequency effect level)

Select to adjust the headphone LFE level.



This menu item is also available in the front panel display system options menu (see page 89).

Note

Depending on the settings of LFE Level, some signals may not be output at the SUBWOOFER jack.

■ Dynamic Range (Dynamic range)

Use to select the amount of dynamic range compression to be applied to your speakers and headphones. This setting is effective only when the unit is decoding Dolby Digital and DTS signals.

To access these parameters, select:

Manual Setup > Sound > Dynamic Range >

Choices: **MAX** (maximum), STD (standard), MIN (minimum)

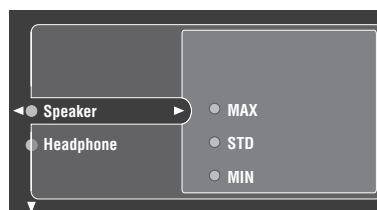

Speaker (Speaker dynamic range)

Select to adjust the speaker compression.

Headphone (Headphone dynamic range)

Select to adjust the headphone compression.

- Select “MAX” to preserve the greatest amount of dynamic range.
- Select “STD” for general use.
- Select “MIN” for listening to sources at low volume levels.



This menu item is also available in the front panel display system options menu (see page 89).

■ Parametric EQ (Parametric equalizer)

Use this feature to adjust the parametric equalizer for any speaker.

Manual Setup > Sound > Parametric EQ >

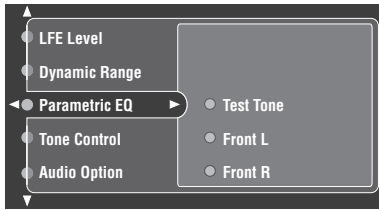

1 Press Δ / ∇ to select Test Tone or the speaker you want to adjust.

- **Test Tone** turns on or off the test tone output when adjusting the tonal quality of each speaker.
- **Front L** adjusts the tonal quality of the front left speaker.
- **Front R** adjusts the tonal quality of the front right speaker.
- **Center** adjusts the tonal quality of the center speaker.
- **Surround L** adjusts the tonal quality of the surround left speaker.
- **Surround R** adjusts the tonal quality of the surround right speaker.
- **Surround Back L** adjusts the tonal quality of the surround back left speaker.
- **Surround Back R** adjusts the tonal quality of the surround back right speaker.
- **Presence L** adjusts the tonal quality of the presence left speaker.
- **Presence R** adjusts the tonal quality of the presence right speaker.

2 Press \triangleright to access the settings window.

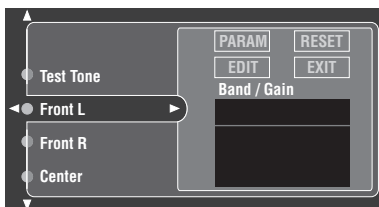

3 Press \triangleleft / \triangleright to select PARAM, then press ENTER to select a parameter from Band (band), Freq. (frequency) or Q (Q factor).

4 Press ∇ to select EDIT and press ENTER to access the edit window.

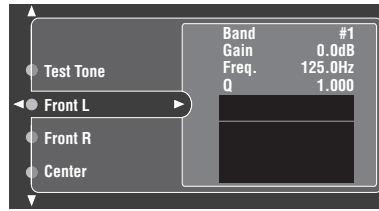

The parameter selected in PARAM is highlighted.

- Press \triangleleft / \triangleright to adjust the parameter.
- Press Δ / ∇ to adjust the Gain.
- Press ENTER to exit the edit window.

5 Repeat steps 3 and 4 until you are satisfied with the results.



If you want to reset all PEQ parameter settings for the selected speaker, select RESET and press ENTER.

6 Select EXIT and press ENTER to exit the settings window.



- If you select “Band” in step 3, you can use this menu as a graphic equalizer.
- For more information on the parametric equalizer, see “PARAMETRIC EQUALIZER INFORMATION” on page 114.

■ Tone Control (Tone control)

Use to adjust the amount of bass and treble output to your speakers and headphones.

Manual Setup > Sound > Tone Control >

Choices: Control, Bass, Treble

Control (Tone control)

Choices: Defeat, Speakers, Headphones

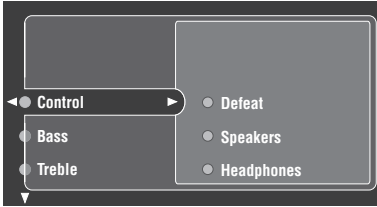

- Select “Defeat” if you do not want to make any adjustments.
- Select “Speakers” to adjust the bass/treble balance of your speakers.
- Select “Headphones” to adjust the bass/treble balance of your headphones.

Bass (Bass control)

Use this feature to adjust low-frequencies output to your speakers or headphones.

Choices: 125Hz, **350Hz**, 500Hz (frequency)
 -6.0dB to +6.0dB (gain), initial setting: 0.0dB

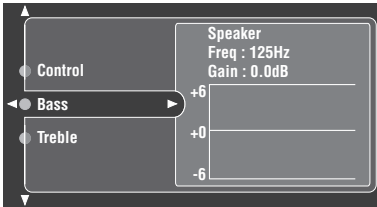

Treble (Treble control)

Use this feature to adjust high-frequencies output to your speakers or headphones.

Choices: 2.5kHz, **3.5kHz**, 8.0kHz (frequency)
 -6.0dB to +6.0dB (gain), initial setting: 0.0dB

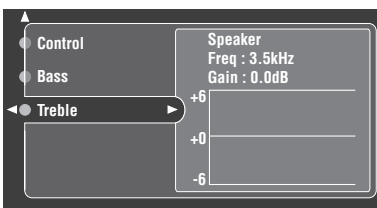

This menu item is also available in the front panel display system options menu (see page 89).

Note

Tone Control is not effective when:

- THX (pages 49 to to 50) or PURE DIRECT (page 38) is selected.
- MULTI CH INPUT is selected.

■ Audio Option (Audio options)

Use to customize this unit’s overall audio settings.

Manual Setup > Sound > Audio Option >

Choices: Muting Type, Audio Delay, PR/SB Select

Muting Type (Muting type)

Use to adjust how much the mute function reduces the output volume.

Choices: **Full**, -20dB

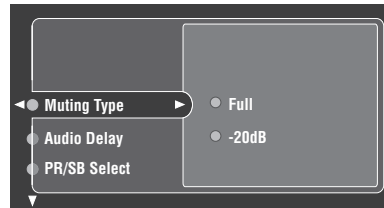

- Select “Full” to completely halt all output of sound.
- Select “-20dB” to reduce the current volume by 20 dB.

Audio Delay (Audio delay)

Use to delay the sound output and synchronize it with the video image. This may be necessary when using certain LCD monitors or projectors.

Choices: **0** to 240 (ms)

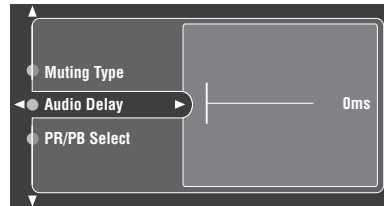

This menu item is also available in the front panel display system options menu (see page 89).

PR/SB Select (Presence/surround back speaker selection)

Surround back and presence speakers do not output sound simultaneously. You can select to prioritize either speaker set when playing sources that contain surround back channel signals using CINEMA DSP sound field programs.

Choices: Presence, **Surround Back**

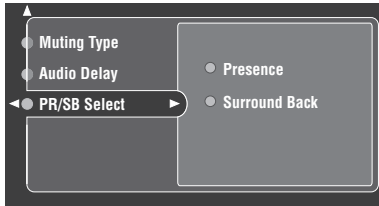

- Select “Presence” to use presence speakers even when surround back channel signals are input. The signals for the surround back channel will be output from surround speakers.
- Select “Surround Back” to use surround back speakers when a surround back channel signal is detected in a CINEMA DSP program. Presence channel signals will be output from front speakers.

Manual Setup (Basic)

Use this menu to set up basic system parameters.

- 1 Set AMP/SOURCE/TV to AMP, then press **TOP** on the remote control.

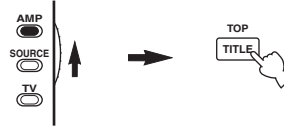

- 2 Select **Manual Setup**, then press **▷**.

- 3 Select **Basic**, then press **▷**.

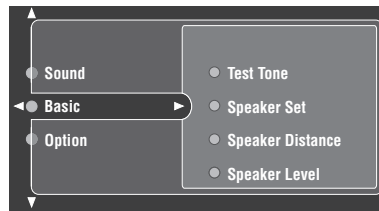

- 4 Select the desired parameters, then press **▷** to access and adjust.



- Most of the parameters described in the basic menu are set automatically when you run auto setup. You can use the basic menu to make further adjustments, but we recommend running auto setup first.
- You can reset these parameters by performing the auto setup procedure (see page 27).

■ Test Tone (Test tone)

Turns the test tone output on or off for Speaker Set, Speaker Distance and Speaker Level settings.

Manual Setup > Basic > Test Tone >

Choices: **Off**, On

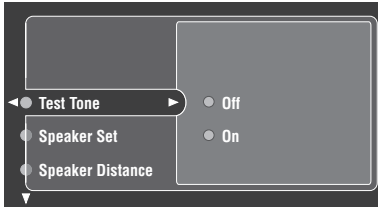

- If you use a handheld SPL meter, hold at arms length and point upwards so that the meter is in the listening position. With the meter set to the 70 dB scale and to C SLOW, calibrate each speaker to 75 dB.
- This menu item is also available in the front panel display system options menu (see page 88).

Note

Loud test tones will be output when “On” is selected. In this case, make sure no children are present in the listening room.

■ Speaker Set (Speaker set)

Use to manually adjust any speaker setting.

Manual Setup > Basic > Speaker Set >

Choices: Front, Center, Surround, Surround Back, Presence, Bass Out, Bass Cross Over, SWFR Phase



If you are not satisfied with the bass sounds from your speakers, you can change these settings according to your preference.

Note

Set any THX speakers to Small.

Front (Front speakers)

Choices: Large, **Small**

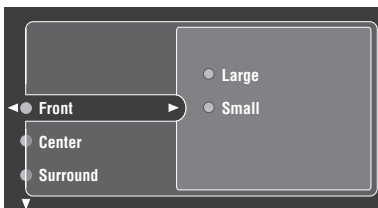

- Select “Large” if you have large front speakers. The unit directs the entire range of the front left and right channel signals to the front left and right speakers.
- Select “Small” if you have small front speakers. The unit directs the low-frequency signals of the front channel to the speakers selected with Bass Out.

Center (Center speaker)

Choices: Large, **Small**, None

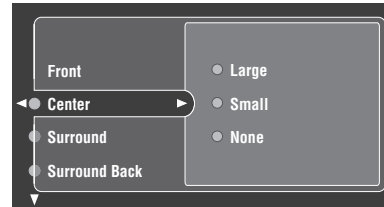

- Select “Large” if you have a large center speaker. The unit directs the entire range of the center channel signal to the center speaker.
- Select “Small” if you have a small center speaker. The unit directs the low-frequency signals of the center channel to the speakers selected with Bass Out.
- Select “None” if you do not have a center speaker. The unit directs all of the center channel signal to the front left and right speakers.

Surround (Surround left/right speakers)

Choices: Large, **Small**, None

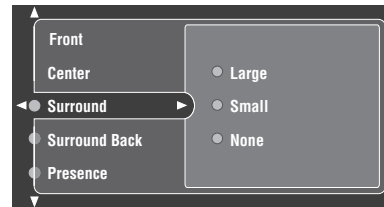

- Select “Large” if you have large surround left and right speakers or if a rear subwoofer is connected to the surround speakers. The entire range of the surround channel signal is directed to the surround left and right speakers.
- Select “Small” if you have small surround left and right speakers. The low-frequency signals of the surround channel are directed to the speakers selected with Bass Out.
- Select “None” if you do not have surround speakers. This sets the unit to the Virtual CINEMA DSP mode (see page 39) and automatically sets the surround back speaker setting (Surround Back) to “None”.

Surround Back (Surround back left/right speakers)

Choices: Large x1, Small x1, **Small x2**, Large x2, None

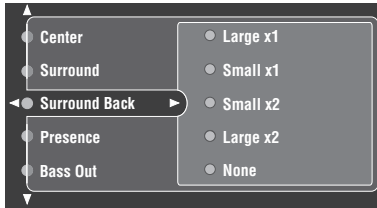

- Select “Large x1” if you have a large surround back speaker. The unit directs the entire range of the surround back channel signal to the surround back left speaker.
- Select “Small x1” if you have a small surround back speaker. The low-frequency signals of the surround back channel are directed to the speakers selected with Bass Out, and the rest of the frequency signals are directed to the surround back left speaker.
- Select “Small x2” if you have two small surround back speakers. The low-frequency signals of the surround back channels are directed to the speakers selected with Bass Out.
- Select “Large x2” if you have two large surround back speakers. The unit directs the entire range of the surround back channel signal to the surround back speakers.
- Select “None” if you do not have a surround back speaker. The unit directs all of the surround back channel signal to the surround left and right speakers.

Note

If you select “Large x1” or “Small x1”, connect a speaker to the SURROUND BACK (SINGLE) speaker terminals.

Presence (Presence speakers)

Choices: None, Yes

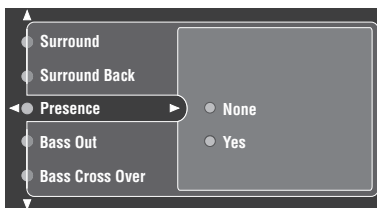

- Select “None” if you do not have presence speakers. This unit directs all presence channel signals to the front left and right speakers.
- Select “Yes” if you have presence speakers.

Note

When Zone2 Amplifier is set to “Internal” (see page 67), Presence is automatically set to “None”.

Bass Out (Bass out)

LFE signals carry low-frequency effects when this unit decodes Dolby Digital or DTS signals. These low-frequency signals can be directed to both front left and right speakers, and to the subwoofer (which can be used for both stereo reproduction and sound field programs).

Choices: Both, **SWFR**, Front
THX recommendation: SWFR

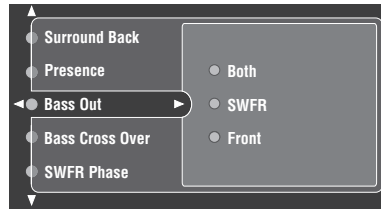

Notes

- Select “Both” to direct LFE signals to the subwoofer. Front L/R low-frequency signals are directed to both the subwoofer and front channels, and all other low-frequency signals are directed in accordance with other speaker settings.
- Select “SWFR” if you connected a subwoofer. The unit directs all LFE and low-frequency signals in accordance with other speaker settings.
- Select “Front” if you have not connected a subwoofer. The unit directs all low-frequency and LFE signals to the front speakers (even if you have previously set Front to Small in Speaker Set).

Bass Cross Over (Bass cross over)

Use this feature to select a cross-over (cut-off) frequency for all low-frequency signals. All frequencies below the selected frequency are sent to the subwoofer.

Choices: 40Hz, 60Hz, **80Hz (THX)**, 90Hz, 100Hz, 110Hz, 120Hz, 160Hz, 200Hz

THX recommendation: 80Hz (THX)

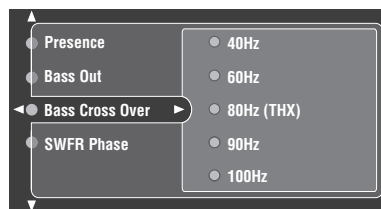

SWFR Phase (Subwoofer Phase)

If bass sounds are lacking or unclear, use this feature to adjust the frequency phase characteristics of your subwoofer.

Choices: **Normal**, Reverse

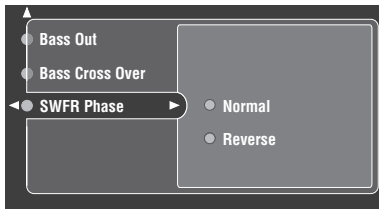

- Select “Normal” not to reverse the phase for your subwoofer(s).
- Select “Reverse” to reverse the phase for your subwoofer(s).



This menu item is also available in the front panel display system options menu (see page 88).

■ Speaker Distance (Speaker distance)

Use this feature to manually input the distance of each speaker and adjust the delay applied to the respective channel. Ideally, each speaker should be the same distance from the main listening position. However, this is not possible in most home situations. Thus, a certain amount of delay must be applied to the sound from each speaker so that all sound will arrive at the listening position at the same time.

Manual Setup > Basic > Speaker Distance >

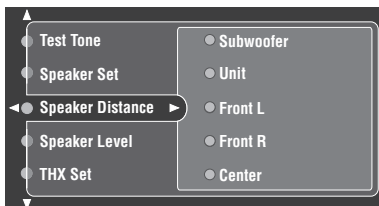

Unit (Unit)

Choices: Meter (m), **Feet** (ft)

Initial setting: U.S.A. and Canada models: Feet (ft)

Other models: Meter (m)

- Select “Meter” to input speaker distances in meters.
- Select “Feet” to input speaker distances in feet.

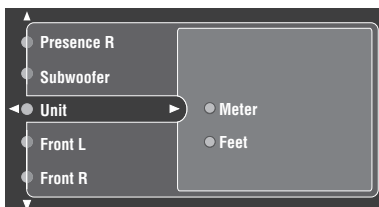

Speaker distances

Choices: 0.30 to 24.00 m (1.0 to 80.0 ft)

Initial setting: 3.00 m (10.0 ft)

- **Front L** adjusts the distance of the front left speaker.
- **Front R** adjusts the distance of the front right speaker.
- **Center** adjusts the distance of the center speaker.
- **Surround L** adjusts the distance of the surround left speaker.
- **Surround R** adjusts the distance of the surround right speaker.
- **Surround Back L** adjusts the distance of the surround back left speaker.
- **Surround Back R** adjusts the distance of the surround back right speaker.
- **Presence L** adjusts the distance of the presence left speaker.
- **Presence R** adjusts the distance of the presence right speaker.
- **Subwoofer** adjusts the distance of the subwoofer.



This menu item is also available in the front panel display system options menu (see page 88).

Notes

- You cannot adjust the distance of speakers set to “None” in Speaker Set.
- If you are only using one surround back speaker, connect it to the SURROUND BACK (SINGLE) jack, and adjust the distance in Surround Back L.

■ Speaker Level (Speaker level)

Use these settings to manually balance the speaker levels between the front left speakers and each speaker selected in Speaker Set (see page 62).

Manual Setup > Basic > Speaker Level

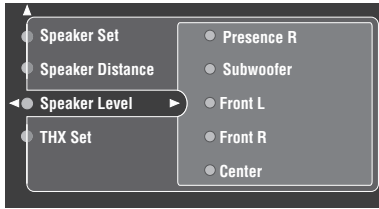

Choices: -10.0 dB to +10.0 dB

Initial setting: 0.0 dB

- **Front L** adjusts the balance of the front left speaker.
- **Front R** adjusts the balance of the front right speaker.
- **Center** adjusts the balance of the center speaker.
- **Surround L** adjusts the balance of the surround left speaker.
- **Surround R** adjusts the balance of the surround right speaker.
- **Surround Back L** adjusts the balance of the surround back left speaker.
- **Surround Back R** adjusts the balance of the surround back right speaker.
- **Presence L** adjusts the balance of the front left and presence left speakers.
- **Presence R** adjusts the balance of the front left and presence right speakers.
- **Subwoofer** adjusts the balance of the subwoofer.



- To calibrate correctly to THX reference levels, use Test Tone (see page 62).
- This menu item is also available in the front panel display system options menu (see page 88).

Notes

- You cannot adjust the level of channels set to “None” in Speaker Set.
- If you are only using one surround back speaker, connect it to the SURROUND BACK (SINGLE) jack, and adjust the balance in Surround Back L.

■ THX Set (THX settings)

Use to manually adjust the THX settings.

Manual Setup > Basic > THX Set >



SB Speaker Dist. (Surround back speaker distance)

Use this feature to optimize the surround sound field when you have to place the surround back speakers apart.

Choices:

U.S.A. and Canada models: under 1ft, 1 – 4ft, over 4ft

Other models: under 0.3m, 0.3 – 1.2m, over 1.2m

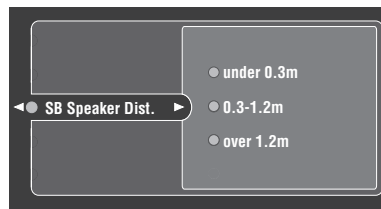

- Select “under 0.3m” or “under 1ft” if the distance between the two surround back speakers is less than 0.3 m (1 ft).
- Select “0.3 – 1.2m” or “1 – 4ft” if the distance between the two surround back speakers is between 0.3 and 1.2 m (1 and 4 ft).
- Select “over 1.2m” or “over 4ft” if the distance between the two surround back speakers is more than 1.2 m (4 ft).



This menu item is also available in the front panel display system options menu (see page 88).

Manual Setup (Option)

This menu adjusts the optional system settings.

- 1 Set AMP/SOURCE/TV to AMP, then press TOP on the remote control.

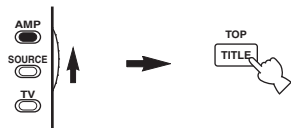

- 2 Select Manual Setup, then press ▷.

- 3 Select Option then press ▷.



- 4 Select the desired parameters, then press ▷ to access and adjust.

- 5 When finished adjusting parameters, press ENTER.

■ Display (Display)

Use this feature to adjust the GUI and front panel displays.
Manual Setup > Option > Display >

Choices: Dimmer, Video Conv., Short Message, Position, Wall Paper

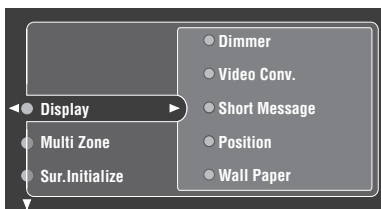

Dimmer (Dimmer)

Use to adjust the brightness of the front panel display.

Choices: -4 to 0

Video Conv. (Video conversion)

Use this feature to turn on/off conversion of composite (VIDEO) signals to both S-video and component signals. This allows you to output converted video signals at the S VIDEO or COMPONENT VIDEO jacks when no S-video or component signals are input. This feature also converts S-video signals to component signals when no component signals are input.

Choices: Off, On

- Select “Off” not to convert any signals.
- Select “On” to convert composite signals to S-video and component signals, and to convert S-video signals to component signals.



When using the THX system, we recommend setting Video Conv. to “Off”.

Notes

- Converted video signals are only output at the MONITOR OUT jacks. When recording you must make the same type of video connections (composite or S-video) between each component.
- When converting composite video or S-video signals from a VCR to component video signals, the picture quality may suffer depending on your VCR.

Short Message (Short message)

Use this feature to turn on/off the short message display.

Choices: Off, On

- Select “Off” to turn off the short message display.
- Select “On” to turn on the short message display.

Notes

- The short message display may not display properly depending on the type of input signal and video monitor used.
- If Video Conv. is set to “Off”, the short message display is not displayed even if “On” is selected.

Position (Position)

Use to adjust the vertical and horizontal position of the GUI display.

Choices: -5 (downward/left) to +5 (upward/right)

- Press ▲ to raise the position of the GUI display.
- Press ▼ to lower the position of the GUI display.
- Press ▷ to shift the position of the GUI display to the right.
- Press ◀ to shift the position of the GUI display to the left.

Wall Paper (Wallpaper)

Use this feature to select the background when no image is input from an external source. If you do not want to display the background, select None.

Choices: None, Yes, Gray

Note

If Video Conv. is set to “Off”, no background is displayed even if “Yes” is selected.



This menu item is also available in the front panel display system options menu (see page 90).

Multi Zone (Multi zone)

Use this feature to customize the Zone 2 and Zone B settings.

Manual Setup > Option > Multi Zone >

Choices: Speaker B, Zone2 Amplifier, Zone2 Volume, Zone3 Volume

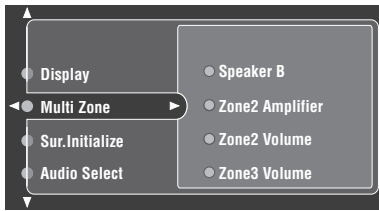

Speaker B (Speaker B)

Use this feature to select the location of the front speakers connected to the SPEAKERS B terminals.

Choices: **Main**, Zone B

- Select “Main” to turn on/off SPEAKERS A and B when the speakers connected to the SPEAKERS B terminals are set in the main room.
- Select “Zone B” if the speakers connected to the SPEAKERS B terminals are set in another room. If SPEAKERS A is turned off and SPEAKERS B is turned on, all the speakers including the subwoofer in the main room are muted and the unit outputs sound from SPEAKERS B only.

Notes

- If you select “Zone B” and connect headphones to the PHONES jack on this unit, the sound is output from both the headphones and SPEAKERS B.
- When a DSP program is selected, the unit automatically enters the Virtual CINEMA DSP mode.

Zone2 Amplifier (Zone 2 amplifier)

Use to select how the ZONE 2 speakers are amplified.

Choices: Internal, **External**

- Select “External” if you connect your Zone 2 speakers through an external amplifier connected to this unit’s ZONE 2 OUTPUT jacks.
- Select “Internal” to use this unit’s internal amplifier if you connect your Zone 2 speakers directly to this unit’s PRESENCE/ZONE 2 speaker terminals.
- Select “None” if you do not want to use the Zone2 feature.

Notes

- When “Internal” is selected, the presence speaker setting automatically switches to “None”.
- When “Internal” is selected, the Zone2 volume setting automatically switches to “Variable”.

Zone2 Volume (Zone 2 volume)

Use to select how the volume control will operate with regard to the ZONE 2 OUTPUT jacks. When Zone2 Amplifier is set to “Internal”, this feature is automatically set to “Variable”.

Choices: Fixed, **Variable**

- Select “Fixed” to fix the ZONE 2 OUTPUT volume level to a standard line level.
- Select “Variable” to adjust the ZONE 2 OUTPUT volume simultaneously using VOL +/- on the remote control.

Zone3 Volume (Zone 3 volume)

Use to select how the volume control will operate with regard to the ZONE 3 OUTPUT jacks.

Choices: Fixed, **Variable**

- Select “Fixed” to fix the ZONE 3 OUTPUT volume level to a standard line level.
- Select “Variable” to adjust the ZONE 3 OUTPUT volume simultaneously using VOL +/- on the remote control.



This menu item is also available in the front panel display system options menu (see page 90).

Sur.Initialize (Surround initialize)

Use this feature to initialize the parameters for each sound field program within sound field program groups. When you initialize a sound field program group, all of the parameter values within that group revert to their initial settings.

Adjusted sound field parameter settings are displayed in blue.

Manual Setup > Option > Sur.Initialize

Choices: STEREO, MUSIC, ENTERTAINMENT, MOVIE THEATER, SURROUND, All

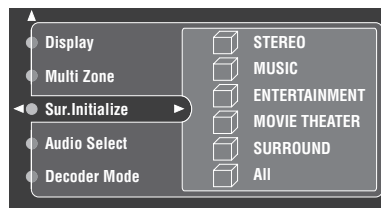

- Press Δ / ∇ to select the sound field program you want to initialize, then press ENTER.
- Select “All” to initialize settings for all sound field program parameters.



This menu item is also available in the front panel display system options menu (see page 90).

Note

Sound field program groups cannot be initialized when Memory Guard is set to “On” (see page 68).

■ Audio Select (Audio selection)

Use this feature to designate the default input mode this unit selects when the power is turned on and the input source (such as a DVD player) is connected to the DIGITAL INPUT jacks on this unit.

Manual Setup > Option > Audio Select

Choices: **Auto**, Last

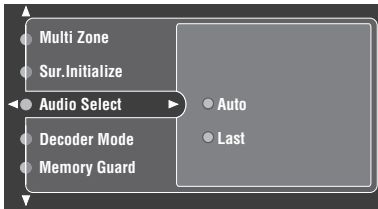

- Select “Auto” if you want this unit to automatically detect input signal types and select the appropriate input mode.
- Select “Last” if you want this unit to automatically select the last input mode used for the connected source.



This menu item is also available in the front panel display system options menu (see page 89).

Note

Selecting “Last” does not recall the last setting for the EXT D SUR. button.

■ Decoder Mode (Decoder mode)

You can select the decoder used by this unit.

Manual Setup > Option > Decoder Mode

Choices: **Auto**, Last

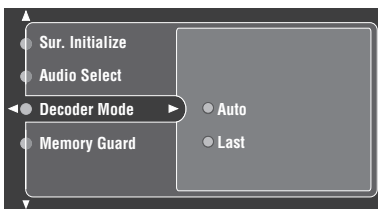

- Select “Auto” if you want this unit to automatically detect input signal types and select the appropriate decoder.
- Select “Last” if you want this unit to automatically select the last decoder used for the connected source.

■ Memory Guard (Memory Guard)

Use this feature to prevent accidental changes to DSP program parameter values and other system settings.

Manual Setup > Option > Memory Guard

Choices: **Off**, On

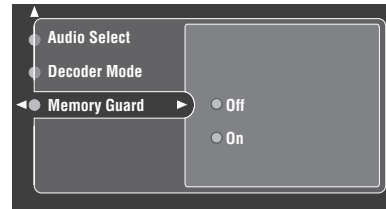

Select “On” to protect:

- DSP program parameters
- All menu items except Memory Guard and System Memory – Load.



This menu item is also available in the front panel display system options menu (see page 90).

Note

In general, front panel and remote control operations are not affected when Memory Guard is set to “On”. However, you cannot adjust the tone control using Tone Control.

System Memory

This feature allows you to save up to six of your favorite settings that can be easily recalled when needed. You can save settings such as the following:

- Sound field program parameters
- Speaker settings
- Speaker channel settings
- LFE level
- Dynamic range settings
- Parametric equalizer settings

■ To save settings

- 1 Set AMP/SOURCE/TV to AMP, then press TOP on the remote control.

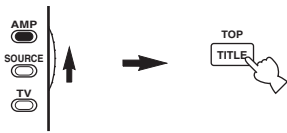

- 2 Select System Memory, then press ▷.

- 3 Select Save, then press ENTER.

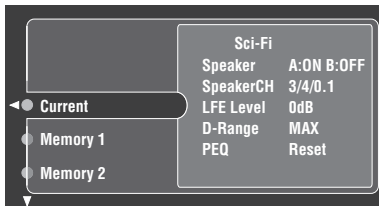

Current displays the current settings of this unit.

- 4 Press △ / ▽ repeatedly to select the memory number under which you want to save the settings, then press ▷.

“Save: ENTER” appears in the bottom right corner of the window.

- 5 Press ENTER to save the settings.

■ To recall settings

- 1 Set AMP/SOURCE/TV to AMP, then press TOP on the remote control.

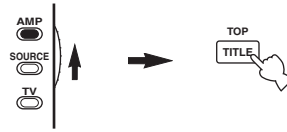

- 2 Select System Memory, then press ▷.

- 3 Select Load, then press ENTER.

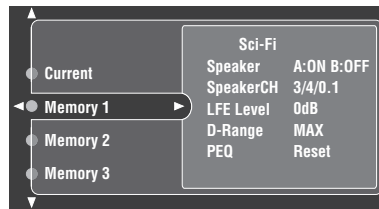

- 4 Press △ / ▽ repeatedly to select the memory number you want to recall, then press ▷.

“Load: ENTER” appears in the bottom right corner of the window.

- 5 Press ENTER to recall the settings.



Memory 1 and Memory 2 settings can be recalled simply by pressing MEMORY 1/2 on the remote control.

When you press MEMORY 1, the message “Load Memory 1?”

Yes:Press Again” appears in the front panel display. Press MEMORY 1 once more to recall the settings.

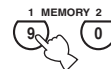

When you press MEMORY 2, the message “Load Memory 2?”

Yes:Press Again” appears in the front panel display. Press MEMORY 2 once more to recall the settings.

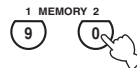

REMOTE CONTROL FEATURES

In addition to controlling this unit, the remote control can also operate other audio and video components made by YAMAHA and other manufacturers. To control these other components, you must set up the remote control with the appropriate remote control codes. This remote control also has a learn feature which allows the remote to acquire functions from other remote controls equipped with an infrared remote control transmitter.

Control area

■ Controlling this unit

The shaded areas below can be used to control this unit after setting AMP/SOURCE/TV to AMP to activate the AMP mode.

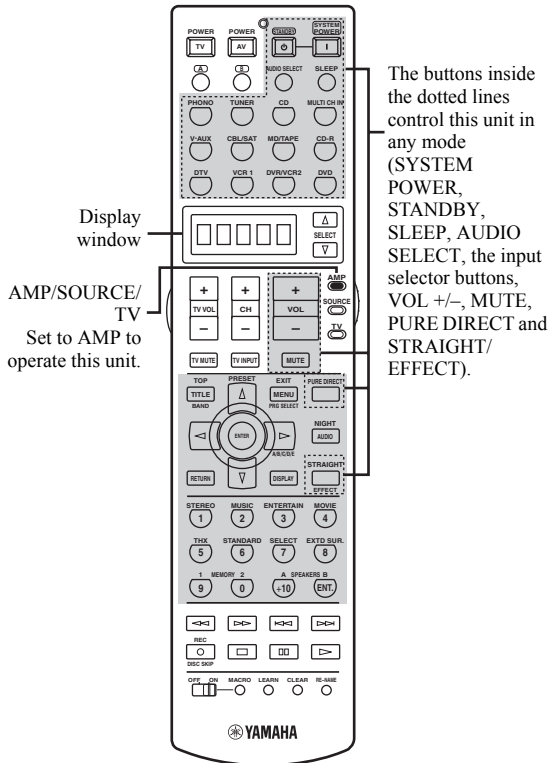

■ Controlling other components

The shaded areas below can be used to control other components. Each button has a different function depending on the selected components. Select the component you want to control by pressing an input selector button or SELECT Δ / ∇ . The name of the selected component appears in the display window.

The A/B and input selector buttons switch the function of the component control area below.
* Use the A/B buttons to control other components regardless of whether they are connected to this unit.
Factory setting:
A...LD player
B...Tape deck

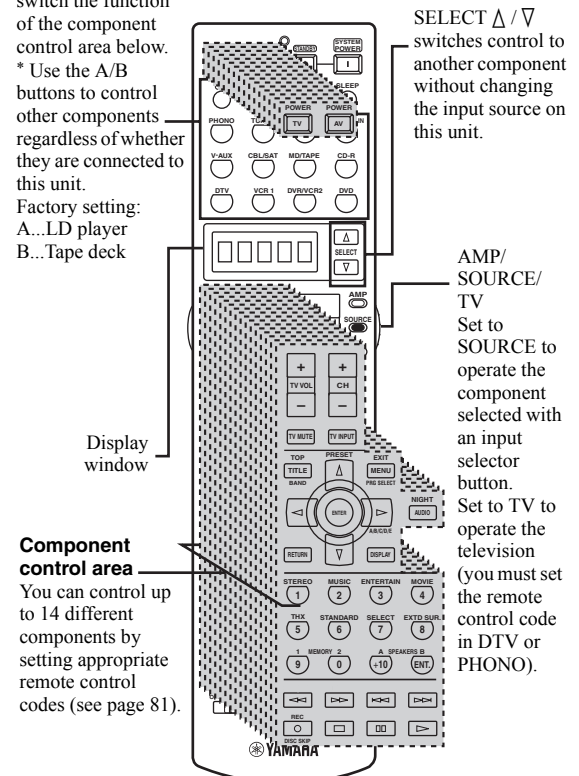

■ Controlling optional components (OPTN area)

OPTN is an additional component control area that can be programmed with remote control functions independently from any input source. This area is useful for programming commands that are to be used only as a part of a macro function or for components that do not have a valid remote control code.

To select the OPTN control area, press ∇ repeatedly until OPTN appears in the display window.

Notes

- You cannot set a remote control code for this area. See page 73 to program buttons operated within this component control area.
- The OPTN area cannot be used when “2001” or “2003” is selected in the amplifier library (see page 72).

Setting remote control codes

You can control other components by setting the appropriate remote control codes. Codes can be set up for each input area. For a complete list of available remote control codes, refer to “LIST OF REMOTE CONTROL CODES” at the end of this manual.

The following table shows the default component (Library: component category) and the remote control code for each input area.

Remote Control Code Default Settings

Input area	Library (component category)	Default YAMAHA code
A	LD	2200
B	TAPE	2700
PHONO	TV	–
TUNER	TUNER	2602
CD	CD	2300
MULTI CH INPUT	DVD	2102
V-AUX	VCR	–
CBL/SAT	CABLE	–
MD/TAPE	MD	2500
CD-R	CD-R	2400
DTV	TV	–
VCR 1	VCR	–
DVR/VCR2	DVR	2807
DVD	DVD	2102

Note

You may not be able to operate your YAMAHA component even if a YAMAHA remote control code is preset as listed above. In this case, try setting another YAMAHA remote control code.

1 Set AMP/SOURCE/TV to SOURCE.

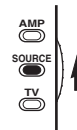

2 Press an input selector button to select the source component you want to set up.

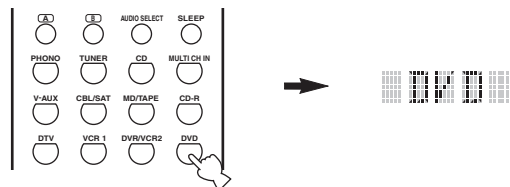

3 Press and hold LEARN for about 3 seconds using a ballpoint pen or similar object.

The library name (ex. “L:DVD”) and the selected component name (ex. “DVD”) appear alternately in the display window.



If you want to setup for another component, press the input selector button or SELECT Δ / ∇ to select the component.

Notes

- Be sure to press and hold LEARN for at least 3 seconds, otherwise the learning process will start.
- If you do not complete each of the following steps within 30 seconds, the setting mode will be automatically canceled. In this case, press LEARN again.

If you want to change a library (component category), press \triangleleft / \triangleright . You can set a different type of component.

Library choices: L:DVD, L:DVR, L:LD, L:CD, L:CDR, L:MD, L:TAP (tape), L:TUN (tuner), L:AMP*, L:TV, L:CAB (cable), L:SAT (satellite), L:VCR

* The amplifier library (L:AMP) code is preset to “2000” in order to operate this unit. However, you can switch by entering one of the following 4 codes if necessary.

Setting remote control AMP codes

Select one of the following codes to set the remote control AMP code for the component you want to use. Set AMP/SOURCE/TV to AMP or SOURCE, then change the remote control code settings.

AMP library code (remote control setting)	Function	Remote control AMP ID (this unit's setting: see page 86)
2000 (initial setting)	To operate this unit using the default code.	ID1 (initial setting)
2001	To operate this unit using the default code. To operate Zone 2 or Zone 3 features (see page 82).	
2002	To operate this unit using an alternative code.	ID2
2003	To operate this unit using an alternative code. To operate Zone 2 or Zone 3 features of other YAMAHA receivers/amplifiers (see page 82).	

Setting remote control tuner codes

Select one of the following codes to set the remote control tuner code for the component you want to use. Set AMP/SOURCE/TV to SOURCE and the unit to the tuner mode by pressing TUNER on the remote control, then change the remote control code settings.

Tuner library code (remote control setting)	Function	Remote control tuner ID (this unit's setting: see page 86)
2602 (initial setting)	To operate this unit using the default code.	ID1 (initial setting)
2603	To operate this unit using an alternative code.	ID2

Note

When using multiple YAMAHA receivers/amplifiers, you may be able to operate the other components simultaneously with the default code setting. In this case, set one of the alternative codes to operate this unit separately.

4 Press ENTER.

The four-digit code set for the selected component appears in the display window.

Note

“0000” appears in the display window if no code has been set.

5 Press the numeric buttons to enter the four-digit remote control code for the component you want to use.

For a complete list of available remote control codes, refer to “LIST OF REMOTE CONTROL CODES” at the end of this manual.

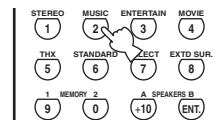

6 Press ENTER to set the number.

“OK” appears in the display window if setting was successful.
“NG” appears in the display window if the setting was unsuccessful. In this case, start over from step 3.



If you continuously want to set up another code for another component, press the input selector button or SELECT Δ / ∇ to select the component, then repeat steps 4 through 6.

7 Press LEARN again to exit from the setup mode.



8 Press one of the buttons shaded below to see if you can control your component. If you can, the remote control code is correct.

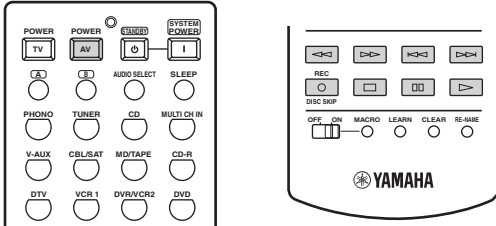

If the manufacturer of your component has more than one code, try each of them until you find the correct one.

Notes

- “ERROR” appears in the display window if you press a button not indicated in the respective step, or when you press more than one button simultaneously.
- The supplied remote control does not contain all possible codes for commercially available audio and video components (including YAMAHA components). If operation is not possible with any of the remote control codes, program the new remote control function using the Learn feature (see “Programming codes from other remote controls (Learn)”) or use the remote control supplied with the component.
- Function programmed using the learn feature take priority over remote control code functions.

Programming codes from other remote controls (Learn)

Use the learn feature if you want to program functions not included in the basic operations covered by remote control codes, or an appropriate remote control code is not available. You can program any of the buttons available in the component control area (see page 70). The buttons can be programmed independently for each component.

Note

This remote control transmits infrared rays. If the other remote control also uses infrared rays, this remote control can learn most of its functions. However, you may not be able to program some special signals or extremely long transmissions. (Refer to the operating instructions for the other remote control.)

1 Set AMP/SOURCE/TV to SOURCE.

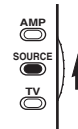

2 Press an input selector button to select a source component.

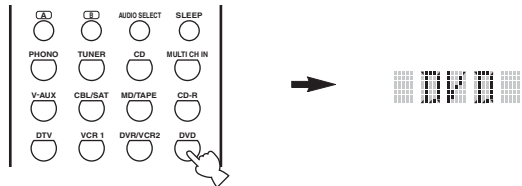

3 Place this remote control about 5 to 10 cm (2 to 4 in) apart from the other remote control on a flat surface so that their infrared transmitters are aimed at each other.

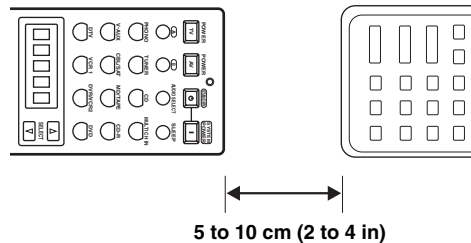

4 Press LEARN using a ballpoint pen or similar object.

“LEARN” and the selected component name (ex. “DVD”) appear alternately in the display window.

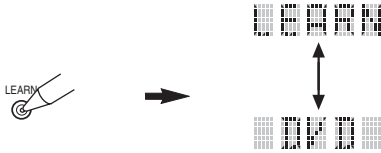

Notes

- Do not press and hold LEARN. If you hold it down for more than 3 seconds, the remote enters the remote control code setting mode.
- If you do not complete each of the following steps within 30 seconds, the learning mode will be automatically canceled. In this case, press LEARN again.

5 Press the button for which you want to program the new function.

“LEARN” appears in the display window.

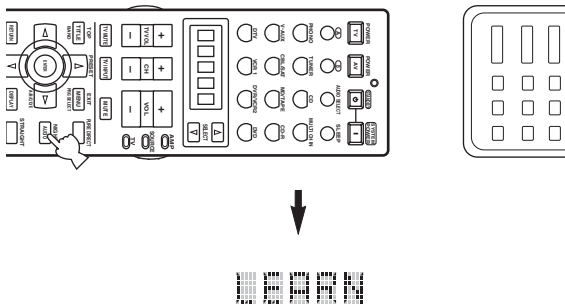

6 Press and hold the button you want to program on the other remote control until “OK” appears in the display window.

“NG” appears in the display window if learning was unsuccessful. In this case, start over from step 5.

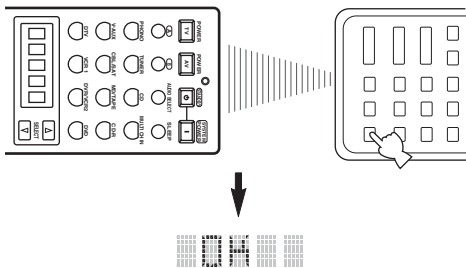

- If you want to program another function, repeat steps 5 and 6.
- If you continuously want to program another function for another component, press SELECT Δ / ∇ to select the component, then repeat steps 5 and 6.

7 Press LEARN again to exit the learning mode.



Notes

- “ERROR” appears in the display window if you press a button not indicated in the respective step, or when you press more than one button simultaneously.
- This remote control can learn approximately 200 functions. However, depending on the signals learned, “FULL” may appear in the display before you program 200 functions. In this case, clear unnecessary programmed functions to make room for further learning.
- Learning may not be possible in the following cases:
 - When the batteries in the remote control for this unit or other components are weak.
 - When the distance between the two remote controls is too great or too small.
 - When the remote control infrared windows are not facing each other at the appropriate angle.
 - When the remote control is exposed to direct sunlight.
 - When the function to be programmed is continuous or uncommon.

Changing source names in the display window

You can change the name that appears in the display window on the remote control if you want to use a different name than the factory preset. This is useful when you have set the input selector to control a different component.

1 Set AMP/SOURCE/TV to AMP or SOURCE.

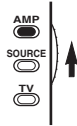

2 Press an input selector button to select the source component you want to rename.

The selected component name appears in the display window.

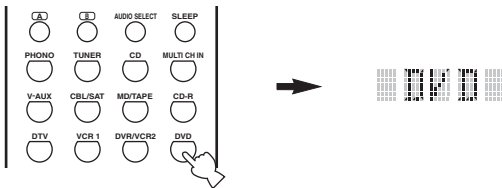

3 Press RE-NAME using a ballpoint pen or similar object.



Note

If you do not complete each of the following steps within 30 seconds, the renaming mode will be automatically canceled. In this case, press RE-NAME again.

4 Press Δ / ∇ to select and enter a character.

Pressing ∇ changes the character as follows:
 A to Z, 1 to 9, 0, + (plus), - (hyphen), ; (semicolon), / (slash), and space.
 (Pressing Δ changes the characters in reverse order.)

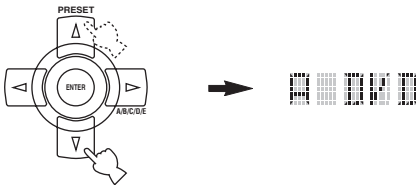

5 Press \triangleleft / \triangleright to move the cursor to the next position.

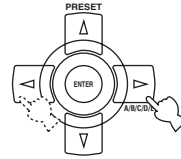

6 Press ENTER to set the new name.

“OK” appears in the display window if renaming was successful.

“NG” appears in the display window if renaming was unsuccessful. In this case, start over from step 4.



If you continuously want to rename another component, press the input selector button or SELECT Δ / ∇ to select the component, then repeat steps 4 through 6.

7 Press RE-NAME again to exit the renaming mode.



Note

“ERROR” appears in the display window if you press a button not indicated in the respective step, or when you press more than one button simultaneously.

Using the Macro feature

The Macro feature makes it possible to perform a series of operations with the press of a single button. For example, when you want to play a CD, normally you would turn on the components, select the CD input, and press the play button to start playback. The Macro feature lets you perform all of these operations simply by pressing the CD macro button. The buttons listed as macro buttons below are factory set with macro programs. You can also program your own macros (see page 77).

Press a macro button



To automatically transmit these signals in order



(CD area)

Macro buttons		First	Second	Third
			—	—
		(*1)	(*2)	—
		—	—	—
		—	—	—
				—
			(*3)	—
				(CD area) (*4)
				—
				—
				—
		(*1)		(MD/TAPE area) (*4)
				(CD-R area) (*4)
				—
				(VCR 1 area) (*4)
				(DVR/VCR 2 area) (*4)
				(DVD area) (*4)

*1 You can turn on some components (including YAMAHA components) connected to this unit by connecting them to the AC OUTLET(S) on the rear panel of this unit. (Power control may not be synchronized with this unit depending on the component. For details, refer to the operating instructions for the connected component.)

*2 When the remote control code for your TV is set up for either DTV or PHONO (see page 71), you can turn on the power of your TV without selecting an input source. The remote control code set up for DTV takes priority over the one for PHONO.

*3 When TUNER is selected as the input source, this unit plays the last station received before the unit was set in the standby mode.

*4 Playback can be started for any YAMAHA remote control-compatible MD recorder, CD player, CD recorder, DVD player, or DVD recorder. When using macros to operate other components, you will need to program the play button on the control area of that component (see page 73) or set a remote control code (see page 71).

Macro operations

Macro buttons

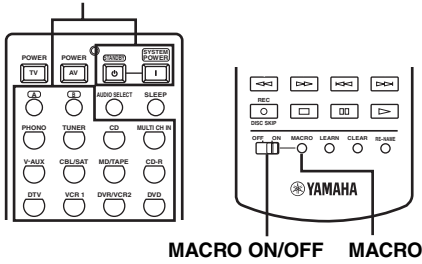

1 Set MACRO ON/OFF to ON.

2 Press a macro button.

Notes

- When you have finished using the Macro feature, set MACRO ON/OFF to OFF.
- While the remote is carrying out a Macro program, it will not accept any other button's function until the macro operation is complete (the transmission indicator stops flashing).
- Continue to aim the remote control at the component the macro is operating until the macro operation is complete.

Programming macro operations

You can program your own macros and use the macro feature to transmit several remote control commands in sequence at the press of a button. Be sure to set up remote control codes or perform learning operations before programming the macro. We do not recommend programming continuous operations such as volume control in a macro.

Notes

- The default macro is not cleared when a new macro is programmed for a button. The default macro can be used again when the programmed macro is cleared.
- It is not possible to add a new signal (macro step) to the default macro. Programming a macro changes all macro contents.

1 Set AMP/SOURCE/TV to AMP or SOURCE.

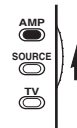

2 Press MACRO using a ballpoint pen or similar object.

“MCR ?” appears in the display window.



Note

If you do not complete each of the following steps within 30 seconds, the macro programming mode will be automatically canceled. In this case, press MACRO again.

3 Press the macro button you want to use to operate the macro.

The macro button name (ex. “M:DVD”) and the selected component name (ex. “DVD”) appear alternately in the display window.

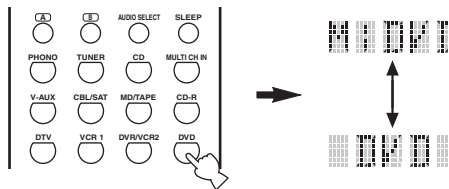

Note

“AGAIN” appears in the display window if you press a button other than a macro button.

4 Press the buttons for the functions you want to include in the macro operation in sequence.

You can set up to 10 steps (10 functions). After you have set 10 steps, "FULL" appears and the remote control automatically exits the macro mode.

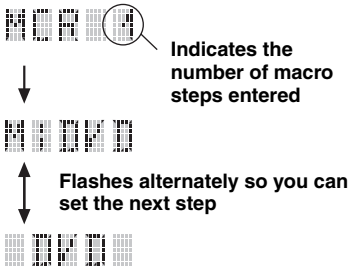
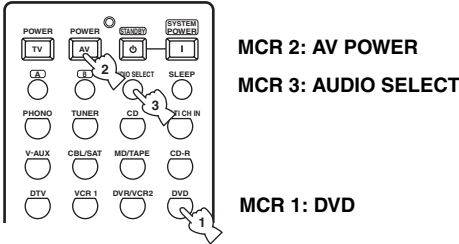

Note

To change the selected source component, press SELECT Δ / ∇ . Pressing the input selector buttons will program a macro step, whereas SELECT Δ / ∇ only changes the selected component and corresponding component control area.

5 Press MACRO again when the operation sequence you want to program is complete.

Note

"ERROR" appears in the display window if you press a button not indicated in the respective step, or if you press more than one button simultaneously.

Memory back-up

If the remote control is without batteries for more than 2 minutes, or if exhausted batteries remain in the remote control, the contents of the memory may be cleared. If the memory is cleared, insert new batteries, set up the remote control code(s) and program any acquired functions that may have been cleared.

Clearing function sets

You can clear all changes made in each function set, such as learned functions, macros, renamed source names and setup remote control codes.

1 Set AMP/SOURCE/TV to AMP or SOURCE.

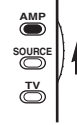

2 Press CLEAR by using a ballpoint pen or similar object.

"CLEAR" appears in the display window.



Note

If you do not complete each of the following steps within 30 seconds, the clearing mode will be automatically canceled. In this case, press CLEAR again.

3 Press Δ / ∇ to select the clear mode.

- L;CD (L: name of a component)
Clears all learned functions in the respective component control area. Press an input selector button to select the component.
- L;AMP
Clears all learned functions for this unit's control area.
- L;ALL
Clears all learned functions.
- M;ALL
Clears all programmed macros
- RNAME
Clears all renamed source names.
- FCTRY
Clears all remote functions and returns the remote to the factory settings.

4 Press and hold CLEAR again for about 3 seconds.

"WAIT" appears in the display window. If clearing was successful, "C;OK" appears in the display window.



Note

Once you have cleared a learned function for a button, the button reverts to the factory setting (or to the manufacturer setting, if you have set remote control codes).

Note

"L;ALL" and "FCTRY" may take about 30 seconds to complete.

5 Press CLEAR to exit from the clear mode.



Notes

- “C;NG” appears in the display window if clearing was unsuccessful. In this case start over from step 3.
- “ERROR” appears in the display window if you press a button not indicated in the respective step, or if you press more than one button simultaneously.

Clearing individual functions

■ Clearing a learned function

You can clear the function learned for a certain button in each control area.

1 Set AMP/SOURCE/TV to SOURCE.

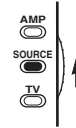

2 Press an input selector button to select the source component containing the function you want to clear.

The selected component name appears in the display window.

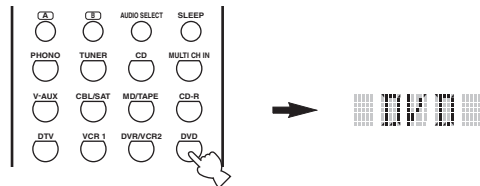

3 Press LEARN using a ballpoint pen or similar object.

“LEARN” and the selected component name (ex. “DVD”) appear alternately in the display window.

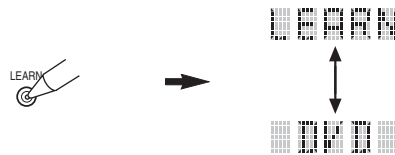

Notes

- Do not press and hold LEARN. If you hold it down for more than 3 seconds, the remote control enters the remote control code setting mode.
- If you do not complete each of the following steps within 30 seconds, the learning mode will be automatically canceled. In this case, press LEARN again.

4 Press and hold CLEAR using a ballpoint pen or similar object, then press the button you want to clear for about 3 seconds.

“C;OK” appears in the display window if clearing was successful.

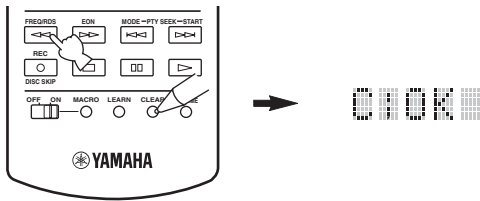

- If you continuously want to clear another function, repeat step 4.
- If you continuously want to clear another function for another component, press SELECT Δ / ∇ to select the component, then repeat step 4.
- Once you clear a learned function, the button reverts to the factory setting (or to the manufacturer setting if you have set remote control codes).

5 Press CLEAR to exit the clearing mode.

The remote control returns to the learning mode.

6 Press LEARN again to exit.

Notes

- “C;NG” appears in the display window if clearing was unsuccessful. In this case, start over from step 4.
- “ERROR” appears in the display window if you press a button not indicated in the respective step, or if you press more than one button simultaneously.

■ Clearing a macro function

You can clear the function programmed for a certain macro button.

1 Set AMP/SOURCE/TV to AMP or SOURCE.

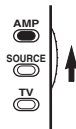

2 Press MACRO using a ballpoint pen or similar object.

“MCR ?” appears in the display window.



Note

If you do not complete each of the following steps within 30 seconds, the macro programming mode will be automatically canceled. In this case, press MACRO again.

3 Press and hold CLEAR using a ballpoint pen or similar object, then press the macro button you want to clear for about 3 seconds.

“C;OK” appears in the display window if clearing was successful.

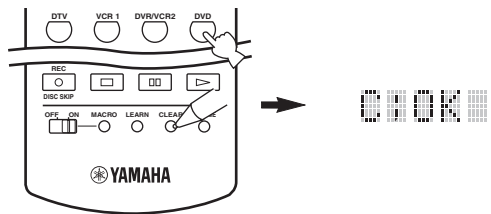

- If you continuously want to clear another function, repeat step 3.
- Once you clear a programmed function, the button reverts to the factory setting (or to the manufacturer setting if you have set remote control codes).

4 Press CLEAR to exit the clearing mode.

The remote control returns to the macro programming mode.

5 Press MACRO again to exit.

Notes

- “C;NG” appears in the display window if clearing was unsuccessful. In this case, start over from step 3.
- “ERROR” appears in the display window if you press a button not indicated in the respective step, or if you press more than one button simultaneously.

Controlling each component

Once you set the appropriate remote control codes, you can use this remote to control your other components. Note that some buttons may not correctly operate the selected component. Use the input selector buttons to select the component you want to operate. The remote control automatically switches to the appropriate control mode for that component.

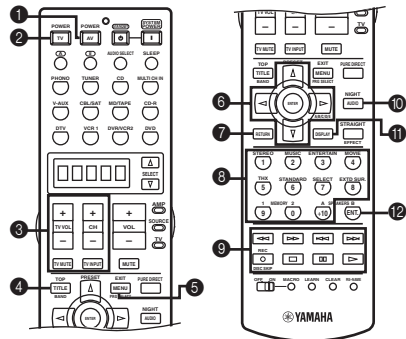

	DVD player/ DVD recorder	VCR	Cable TV/ Satellite tuner	TV	LD player	CD player	MD recorder/ CD recorder	Tape deck	Tuner
1 AV POWER	Power *1	Power *1	Power *1	VCR power *3	Power *1	Power *1	Power *1	Power *1	Power *1
2 TV POWER	TV power *2	TV power *2	TV power *2	Power *1	TV power *2	TV power *2	TV power *2	TV power *2	TV power *2
3 TV VOL +	TV volume + *2	TV volume + *2	TV volume + *2	Volume +	TV volume + *2	TV volume + *2	TV volume + *2	TV volume + *2	TV volume + *2
TV VOL -	TV volume - *2	TV volume - *2	TV volume - *2	Volume -	TV volume - *2	TV volume - *2	TV volume - *2	TV volume - *2	TV volume - *2
CH +	TV channel + *2	Channel +	Channel +	Channel +	TV channel + *2	TV channel + *2	TV channel + *2	TV channel + *2	TV channel + *2
CH -	TV channel - *2	Channel -	Channel -	Channel -	TV channel - *2	TV channel - *2	TV channel - *2	TV channel - *2	TV channel - *2
TV INPUT	TV input *2	TV input *2	TV input *2	Input	TV input *2	TV input *2	TV input *2	TV input *2	TV input *2
TV MUTE	TV mute *2	TV mute *2	TV mute *2	Mute	TV mute *2	TV mute *2	TV mute *2	TV mute *2	TV mute *2
4 TITLE	Title	Title	Title	Title					Band
5 MENU	Menu		Menu	Menu					Program select*5
6 ENTER	Menu enter		Menu select	Menu select					
Δ	Menu up		Menu up	Menu up					Preset up (1 to 8)
∇	Menu down		Menu down	Menu down					Preset down (1 to 8)
◁	Menu left		Menu left	Menu left					Preset down (A to E)
▷	Menu right		Menu right	Menu right			Direction A/B		Preset up (A to E)
7 RETURN	Return	Return	Return	Return					
8 1-9, 0, +10	Numeric buttons	Numeric buttons	Numeric buttons	Numeric buttons	Numeric buttons	Numeric buttons	Numeric buttons		Preset stations (1-8)
9 ◀◀	Search backward	Search backward	VCR search backward *3	VCR search backward *3	Search backward	Search backward	Search backward	Search backward	FREQ *4
▶▶	Search forward	Search forward	VCR search forward *3	VCR search forward *3	Search forward	Search forward	Search forward	Search forward	EON *4
⏮	Skip backward				Chapter/Skip backward	Skip backward	Skip backward	Direction back	PTY MODE *4
⏭	Skip forward				Chapter/Skip forward	Skip forward	Skip forward	Direction forward	PTY START *4
REC/ DISC SKIP	Disc skip (player) Rec (recorder)	Rec	VCR rec *3	VCR rec *3		Disc skip	Rec	Rec	
□	Stop	Stop	VCR stop *3	VCR stop *3	Stop	Stop	Stop	Stop	
⏸	Pause	Pause	VCR pause *3	VCR pause *3	Pause	Pause	Pause	Pause	
▶	Play	Play	VCR play *3	VCR play *3	Play	Play	Play	Play	
10 AUDIO	Audio				Audio				
11 DISPLAY	Display		Display	Display	Display	Display	Display		Display*5
12 ENTER		Enter	Enter/recall	Enter/ numeric button					

*1 This button functions only when the original remote control of the component has a POWER button.

*2 These buttons can operate your TV without switching the input if the remote control code is set in DTV or PHONO.

When the remote control code for your TV is set up in both the DTV and PHONO areas, priority is given to the signal in the DTV area.

*3 These buttons can operate your VCR without switching the input to VCR 1 if the remote control code is set in VCR 1.

*4 These buttons function for U.K. and Europe models only.

*5 These buttons function for the U.S.A. model only.

ZONE 2/ZONE 3

This unit allows you to configure a multi-room audio system. The Zone 2 and Zone 3 features enable you to set this unit to reproduce separate input sources in the main room, second room (Zone 2) and third room (Zone 3). You can control this unit from the second or third room using the supplied remote control.

Only analog signals are sent to the second and third rooms. Any source you want to listen to in the second or third room must be connected using the analog (AUDIO L/R) input jacks on this unit.

Zone 2/Zone 3 connections

You need the following additional equipment to use the multi-room functions of this unit:

- An infrared signal receiver in the second and/or third room.
- An infrared emitter in the main room. This emitter transmits the infrared signals from the remote control in the second and/or third room to the main room (to a CD player or DVD player, for example).
- An amplifier and speakers for the second and/or third room.
- A video monitor for the second room.

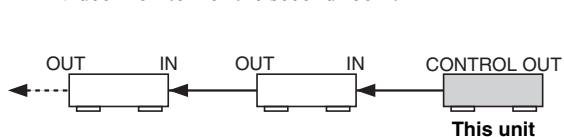

- Since there are many possible ways to connect and use this unit in a multi-room configuration, we recommend that you consult with your nearest authorized YAMAHA dealer or service center for the Zone 2/Zone 3 connections that best meet your requirements.
- Some YAMAHA models are able to connect directly to the CONTROL OUT jack on this unit. If you own these products, you may not need to use an infrared emitter. Up to six YAMAHA components can be connected as shown.

System configuration and connections example

Using external amplifiers

To use an external amplifier in Zone 2, select “External” in Zone2 Amplifier (page 67).

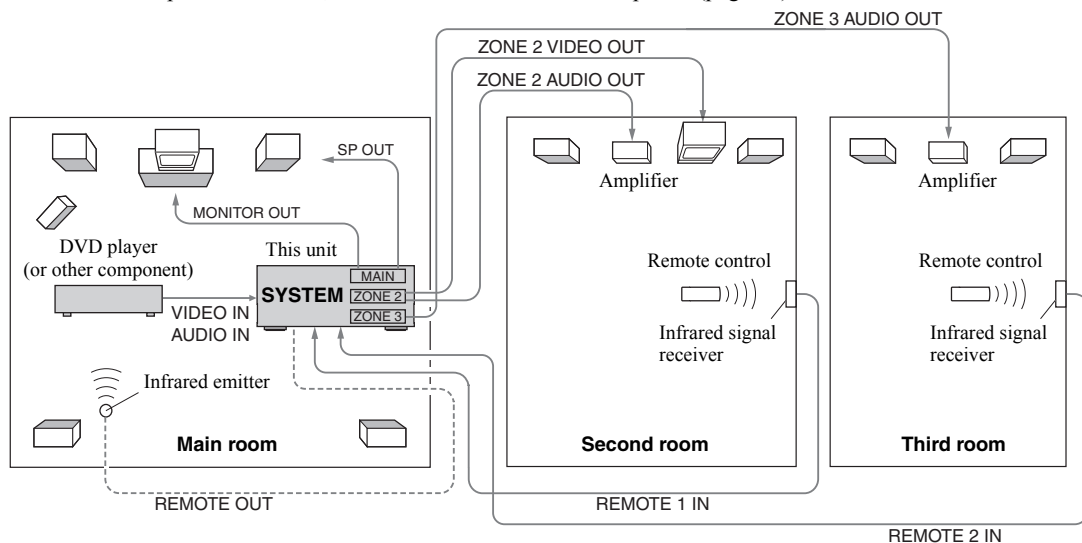

Notes

- When not using the main room, turn down the volume of this unit in the main room. Adjust the Zone 2/Zone 3 volume by using the amplifier in the second/third room.
- To avoid unexpected noise, DO NOT USE the Zone 2/Zone 3 feature with CDs encoded in DTS.

Using this unit's internal amplifier

To use this unit's internal amplifier, select "Internal" in Zone2 Amplifier 2 (page 67).

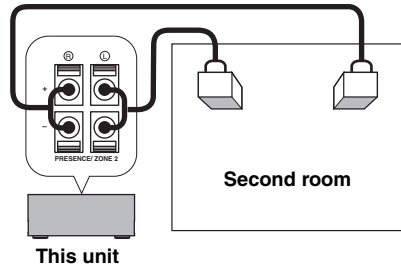

Controlling Zone 2/Zone 3 from the front panel

You can control the input or adjust the volume level for Zone 2 and Zone 3 components using ZONE CONTROL on the front panel.

1 Set REC OUT/ZONE 2 on the front panel to SOURCE/REMOTE.

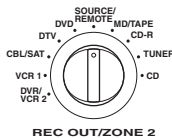

2 Press MAIN, ZONE 2 or ZONE 3 to select the zone you want to change the input for or adjust the volume level.

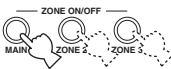

Press each button repeatedly to turn the respective zone on or off.

You can choose from the following modes:

- ZONE2** Controls the Zone 2 component connected to the ZONE 2 AUDIO L/R jacks on this unit.
- ZONE3** Controls the Zone 3 component connected to the ZONE 3 AUDIO L/R jacks on this unit.
- MAIN** Controls the main component (this unit).

3 Press ZONE CONTROL on the front panel repeatedly to choose the zone you selected in step 2.



Each time you press ZONE CONTROL, the front panel display changes as shown below, and the indicator for the currently selected zone flashes for approximately 5 seconds.

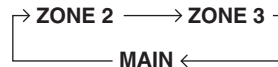

- You must complete this step within 5 seconds of pressing ZONE CONTROL on the front panel. Otherwise, the zone mode selection process is automatically canceled. In this case, press ZONE CONTROL again.
- The initial setting is "ZONE 2" when both the Zone 2 and Zone 3 components connected to this unit are turned on.
- If you selected MAIN in step 2, no indicator flashes on the front panel display when ZONE CONTROL is pressed.

4 Use the INPUT or VOLUME selector on the front panel to switch the input or adjust the volume level for the selected zone component.

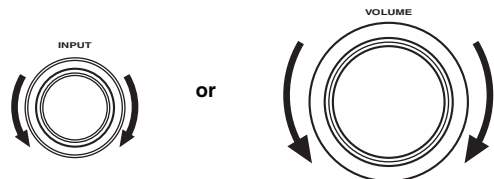

You must complete this step within 5 seconds of performing step 2. Otherwise, the zone mode selection process is automatically canceled. In this case, repeat steps 2 and 3 again.

Controlling Zone 2/Zone 3 using the remote control

The supplied remote control can be used to control Zone 2/Zone 3. You can even select the input source and control components located in the main room directly from the second/third room regardless of the listening condition in the main room.

To enable Zone mode on the remote control

You will be able to switch the remote control mode from one room to another, and use the input selector, STANDBY, SYSTEM POWER, MUTE and VOLUME +/- to control the selected room.

- 1 Set REC OUT/ZONE 2 on the front panel to SOURCE/REMOTE.

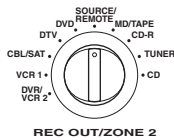

- 2 Repeat steps 1 through 3 of the procedure in "Setting remote control codes" on page 71.

- 3 Press ◀/▶ to select "L;AMP".

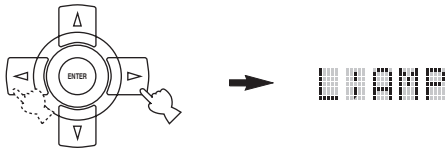

- 4 Press ENTER. "2000" appears in the display window.

- 5 Enter the code number "2001" or "2003". For details, see page 72.

- 6 Press ENTER to set the number. "OK" appears in the display window if setting was successful.

- 7 Press LEARN to complete the Zone setup. The remote control will be able to operate this unit from Zone 2 or Zone 3.



To control Zone 2/Zone 3

- 1 Press SELECT ▲ repeatedly to display "ZONE 2" or "ZONE 3" in the display window.

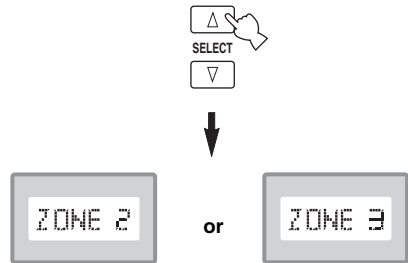

- 2 Press SYSTEM POWER to turn Zone 2 or Zone 3 power on.

- 3 Press an input selector button to select the input source you want to listen to in the second/third room.

The display window shows "2: name of selected input" or "3: name of selected input" if the remote control is in the Zone 2/Zone 3 mode.

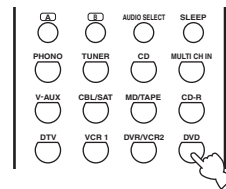

Note

Signals input at V-AUX and PHONO jacks cannot be sent to Zone 2/Zone 3.

- 4 You can control the unit from Zone 2 or Zone 3 by using the input selector, STANDBY, SYSTEM POWER, MUTE and VOLUME +/- buttons.

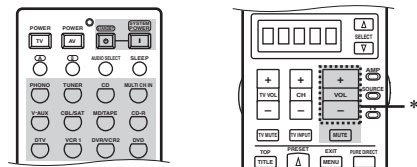

* VOLUME +/- can be used only when Zone2 Volume or Zone3 Volume is set to "Variable" in the GUI menu (see page 67).

5 Press SELECT Δ / ∇ to exit from the Zone 2/Zone 3 mode.

Notes

- The source in Zone 2 and the source available for recording are always the same.
- “ZONE2” or “ZONE3” will appear in the display window only when Δ is pressed, and “SYSTEM” only when ∇ is pressed.

Turning on this unit or setting it to the standby mode

SYSTEM POWER and STANDBY work differently depending on the selected mode that appears on the display window.

- When normal, Zone 2 or Zone 3 mode is selected, you can turn on the main unit, Zone 2 or Zone 3 or set them to the standby mode individually.
- When System mode is selected, or when “2000” or “2002” (see page 72) is selected as the amplifier library (L;AMP) code, pressing SYSTEM POWER turns on the main unit only. However, pressing STANDBY sets everything (the main unit, Zone 2 and Zone 3) to the standby mode simultaneously.

	LCD display	SYSTEM POWER/ STANDBY
Normal mode*	Name of component	Turns on the main unit only or sets it to the standby mode.
Zone 2 mode	“Zone2” or “2:name of component”	Turns on Zone 2 or sets it to the standby mode.
Zone 3 mode	“Zone3” or “3:name of component”	Turns on Zone 3 or sets it to the standby mode.
System mode	“SYSTEM”	SYSTEM POWER: turns on the main unit only. STANDBY: sets everything (the main unit, Zone 2 and Zone 3) to the standby mode simultaneously.

* “MAIN” appears for a few seconds when SYSTEM POWER or STANDBY is pressed.

Note

To control Zone 2 or Zone 3 again when System mode is selected and the main unit, Zone 2 and Zone 3 are in the standby mode, press SYSTEM POWER to turn on the main unit, then repeat steps 1 through 5 of the procedure in “To control Zone 2/Zone 3” on pages 84 and 85.

Special considerations for DTS software

The DTS signal is a digital bitstream. If you attempt to send the DTS signal to the second/third room you will only hear digital noise (that may damage your speakers). Thus, the following considerations and adjustments need to be made when playing DTS encoded discs.

For DVDs encoded with DTS

Only 2 channel analog audio signals may be sent to the second/third room.

Use the disc menu to set the DVD player’s mixed 2-channel left and right audio outputs to the PCM or Dolby Digital soundtrack.

For CDs encoded in DTS

To avoid unexpected noise, DO NOT USE the Zone 2/Zone 3 feature with CDs encoded in DTS.

FRONT PANEL DISPLAY MENUS

This unit has additional menus that are displayed in the front panel display.

Advanced setup menu

This menu offers additional operations to adjust and customize the way this unit operates. Change the initial settings (indicated in bold under each parameter) to reflect the needs of your listening environment.

1 Make sure this unit is in the standby mode.

2 On the front panel, while holding down STRAIGHT/EFFECT, press STANDBY/ON.



3 Rotate PROGRAM to select the desired menu item.

The name of the selected item appears in the front panel display.



4 Press STRAIGHT/EFFECT to change the setting.

5 Press STANDBY/ON to save the new setting

This unit enters the standby mode.



The new setting is activated next time you turn on the power of this unit.

Note

The remote controls and VOLUME control on the front panel of this unit are ineffective while you are using the advanced setup menu.

■ SP IMP. (Speaker impedance)

Use to set the impedance of this unit so that it matches that of your speakers.

Choices: **6ΩMIN**, **8ΩMIN**

- Select “6ΩMIN” for speakers 6 ohms or higher.
- Select “8ΩMIN” for speakers 8 ohms or higher.

■ PRESET (User preset)

Use to reset all of this unit’s parameters to the initial factory settings with the exception of System Memory and Auto Setup settings.

Choices: **CANCEL**, RESET

- Select “CANCEL” if you do not want to reset this unit’s parameters.
- Select “RESET” to reset this unit’s parameters.

Note

This setting does not affect advanced setup menu item parameters.

■ REMOTE AMP (Remote control AMP ID)

Use to set this unit’s ID for remote control recognition (see page 72).

Choices: **ID1**, ID2

- Select “ID1” when the remote control amplifier library code is set to “2000” or “2001”.
- Select “ID2” when the remote control amplifier library code is set to “2002” or “2003”.

■ REMOTE TUN (Remote control tuner ID)

Use to set this unit’s tuner ID for remote control recognition (see page 72).

Choices: **ID1**, ID2

- Select “ID1” when the remote control tuner library code is set to “2602”.
- Select “ID2” when the remote control tuner library code is set to “2603”.

■ FAN MODE (Fan operation mode)

Use to set the operation of this unit’s cooling fan.

Choices: **AUTO**, CONT.

- Select “AUTO” to set the fan to operate automatically according to the temperature of this unit.
- Select “CONT.” to set the fan to operate continuously regardless of the temperature of this unit.

< Asia and General models only >

■ TU (Tuner frequency step)

Use to set the tuner frequency step according to the frequency spacing in your area.

Choices: AM10/FM100, **AM9/FM50**

- Select “AM10/FM100” for North, Central and South America.
- Select “AM9/FM50” for all other areas.

■ LANG. (GUI language)

Use to set the language that appears in this unit’s GUI (graphical user interface) display.

Choices: **ENGLISH**, JAPANESE, FRENCH, GERMAN

You can select the language of your choice.

Front panel display system options menu

This is a complimentary menu that allows you to access most GUI menu system option parameters without using a video monitor.

Use the remote control to access and adjust each parameter.

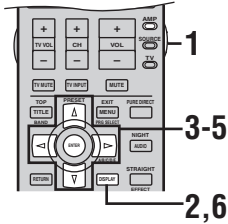

1 Set AMP/SOURCE/TV to AMP.

2 Press DISPLAY on the remote control to enter the menu.

■ AUTO SETUP

Item	Sub-items	Features
SETUP	AUTO	<ul style="list-style-type: none"> • Use to specify the speaker parameters auto setup adjusts. • Corresponds to Setup Type in the GUI menu (see page 29).
EQ	NATURAL FRONT FLAT	<ul style="list-style-type: none"> • Use to specify the equalizer characteristics auto setup uses. • Corresponds to Setup Menu – Equalizing in the GUI menu (see page 28).
START [ENTER]		<ul style="list-style-type: none"> • Use to activate the auto setup procedure. • Corresponds to Start in the GUI menu (see page 29).

3 Press Δ / ∇ repeatedly to select an item, then press ENTER to enter the selected item.

4 Press Δ / ∇ repeatedly to select the parameter you want to adjust.

5 Press ENTER, then press $\triangleleft / \triangleright$ repeatedly to change the setting of the item you want to adjust.

6 Press DISPLAY to exit.



If you want to adjust another parameter, press RETURN to return to the previously selected menu item.

■ MANUAL SETUP

1 BASIC MENU

Item	Sub-items	Features
A>SPEAKER SET	FRONT.....SMALL CENTER.....SML SURR LR.....SML SURR B.....SMLx2 PRESENCE..NONE BASS OUT..SWFR CrossOver..80Hz SWFR PHASE..NRM	<ul style="list-style-type: none"> • Selects the output mode suitable for each speaker, the speakers for low-frequency signal output, and the cross over frequency. • Corresponds to Speaker Set in the GUI menu (see page 62).
B>SP DISTANCE	UNIT.....meters FRONT L..3.00m FRONT R..3.00m CENTER...3.00m SURR L...3.00m SURR R...3.00m SB L.....3.00m SB R.....3.00m SWFR.....3.00m PRES L...3.00m PRES R...3.00m	<ul style="list-style-type: none"> • Adjusts the delay time of each speaker. • Corresponds to Speaker Distance in the GUI menu (see page 64). • Set the unit to “meters” or “feet” to input speaker distances in meters or in feet.
	UNIT.....feet FRONT L..10.00ft FRONT R..10.00ft CENTER...10.00ft SURR L...10.00ft SURR R...10.00ft SB L.....10.00ft SB R.....10.00ft SWFR.....10.00ft PRES L...10.00ft PRES R...10.00ft	
C>SP LEVEL	FL----- ----- C----- ----- FR----- ----- SL----- ----- SB.L----- ----- SB.R----- ----- SR----- ----- SWFR----- ----- PR.R----- ----- PR.L----- -----	<ul style="list-style-type: none"> • Adjusts the output level of each speaker. • Corresponds to Speaker Level in the GUI menu (see page 65).
D>TEST TONE	TEST TONE..OFF TEST TONE...ON	<ul style="list-style-type: none"> • Outputs a test tone to calibrate your speaker levels. • Corresponds to Test Tone in the GUI menu (see page 62).
E>THX SET	SB Dis: <0.3m SB Dis: 0.3-1.2m SB Dis: >1.2m	<ul style="list-style-type: none"> • Adjusts the THX settings. • Corresponds to THX Set in the GUI menu (see page 65).

2 SOUND MENU

Item	Sub-items	Features
A>LFE LEVEL	SP LFE.....0 HP LFE.....0	<ul style="list-style-type: none"> Adjusts the output level of the LFE channel for Dolby Digital or DTS signals. Corresponds to LFE Level in the GUI menu (see page 58).
B>D. RANGE	SP D.R....MAX HP D.R....MAX	<ul style="list-style-type: none"> Adjusts the dynamic range for Dolby Digital or DTS signals. Corresponds to Dynamic Range in the GUI menu (see page 58).
C>TONE CON FRQ	BASS SP 350Hz TRBL SP 3.5kHz	<ul style="list-style-type: none"> Adjusts the tonal balance of the speakers and headphones. Corresponds to Tone Control in the GUI menu (see page 60). “BASS SP” and “TRBL SP” appear when no headphones are connected to this unit, and “BASS HP” and “TRBL HP” appear when headphones are connected to this unit.
	BASS HP 350Hz TRBL HP 3.5kHz	
D>AUDIO OPTION	A. MUTE....MUTE A. DELAY....0ms PRch >SBch	<ul style="list-style-type: none"> Customizes overall audio settings for this unit. Corresponds to Audio Option in the GUI menu (see page 60).

3 INPUT MENU

Item	Sub-items	Features
A>I/O ASSIGN	C.V[IA] DVD C.V[IB] DTU C.V[IC]CBL/SAT OUT(1)MD/TAPE OUT(2) CD-R IN (3) CD IN (4) DVD IN (5) DTU IN (6) CBL/SAT IN (7) CD IN (8) DVD IN (9)DUR/VCR2	<ul style="list-style-type: none"> Assigns jacks according to the component to be used. Corresponds to I/O assignment in the GUI menu (see page 55).
B>INPUT TRIM	DVD.....0.0	<ul style="list-style-type: none"> Adjusts the output volume of each jack. Corresponds to Volume Trim in the GUI menu (see page 56).
C>AUDIO SELECT	>AUTO LAST	<ul style="list-style-type: none"> Selects the initial input mode of the source. Corresponds to Audio Select in the GUI menu (see page 68).
D>DECODER MODE	>AUTO LAST	<ul style="list-style-type: none"> Selects the decoder used by this unit. Corresponds to Decoder Mode in the GUI menu (see page 56).
E>INPUT RENAME	DVD +_ DVD	<ul style="list-style-type: none"> Changes the name of the input. Corresponds to Rename in the GUI menu (see page 57).
F>MULTI CH IN	>6CH 8CH	<ul style="list-style-type: none"> Selects the number of audio channels input at the MULTI CH INPUT jacks. Corresponds to Multi CH Assign in the GUI menu (see page 57).

4 HDMI MENU

Item	Sub-items	Features
A>INPUT ASSIGN	IN 1 DVD IN 2 CBL/SAT	<ul style="list-style-type: none"> Assigns input sources (such as a DVD player) to the HDMI IN jacks. Corresponds to Input Assign in the GUI menu (see page 98).
B>SUPPORT AUD.	>4600 OTHER	<ul style="list-style-type: none"> Selects the HDMI audio signal playback source. Corresponds to Support Audio in the GUI menu (see page 98).

5 i.LINK MENU

Item	Sub-items	Features
A>INPUT ASSIGN	----> --- ----> DVD	<ul style="list-style-type: none"> Selects the input assignment for registered i.LINK components. Corresponds to Input Assign in the GUI menu (see page 93). “---” appears if no i.LINK component is registered.
B>AUTO PLAY	<----> PLAYER ----> PLAYER <----> PLAYER --X--> PLAYER	<ul style="list-style-type: none"> Selects automatic playback for signals input from i.LINK components connected to this unit. Corresponds to Auto Play in the GUI menu (see page 93).

6 OPTION MENU

Item	Sub-items	Features
A>DISPLAY SET	DIMMER.....0 WALL PAPER..ON SHORT MSG. ON V CONU.....ON	<ul style="list-style-type: none"> Adjusts the GUI and front panel displays. Corresponds to Display in the GUI menu (see page 66).
B>MEMORY GUARD	MEM.GUARD..OFF	<ul style="list-style-type: none"> Locks the menu parameter settings. Corresponds to Memory Guard in the GUI menu (see page 68).
C>SURR. INI	PRESS DSP Key	<ul style="list-style-type: none"> Initializes the parameters of all or a group of sound field programs. Corresponds to Sur.Initialize in the GUI menu (see page 67).
D>ZONE SET	SP B....MAIN	<ul style="list-style-type: none"> Customizes the Zone B parameters. Corresponds to Multi Zone in the GUI menu (see page 67).
E>ZONE2 SET	OUT VOL...VAR. ZONE2 AMP..EXT	<ul style="list-style-type: none"> Customizes the Zone 2 parameters. Corresponds to Multi Zone in the GUI menu (see page 67).
F>ZONE3 SET	OUT VOL...VAR.	<ul style="list-style-type: none"> Customizes the Zone 3 parameters. Corresponds to Multi Zone in the GUI menu (see page 67).

USING i.LINK

What is i.LINK?

i.LINK is a high-speed and bi-directional digital interface in compliance with a global standard approved by the Institute of Electrical and Electronics Engineers (IEEE).

i.LINK enables i.LINK-compatible components to send and receive digital audio signals (bitstreams such as Dolby Digital, and DTS; 2-channel linear PCM signals; DSD signals of Super Audio CD) over a single i.LINK cable.

You can process audio signals by selecting between the DSD Direct mode where DSD signals are directly output to DSD-compatible audio DAC and the DSD mode where DSD signals are changed to PCM signals to ensure rich sound fields.

i.LINK currently supports three different data transfer rates: 100 Mbps, 200 Mbps and 400 Mbps.

This unit supports hot plugging, a function that allows you to disconnect or connect the IEEE1394 cable while the power is turned on.

This unit's i.LINK interface was based on the following design standards:

- IEEE1394 Std 1394a-2000 (Standard for a High Performance Serial Bus)
- A&M Protocol (Audio and Music Data Transmission Protocol 2.1)
- DTCP (Digital Transmission Content Protection)

i.LINK compatibility with this unit

Audio signal types	Audio signal formats	Compatible i.LINK components
2ch Linear PCM	2ch, 32-192 kHz	CD, DVD-Video, DVD-Audio
Multi-ch Linear PCM	5.1 ch, 32-96 kHz	DVD-Audio
Bitstream	Dolby Digital, DTS	DVD-Video
DSD	2ch/5ch/6ch 2.8224 MHz	Super Audio CD

Connecting i.LINK components

■ Daisy chain connections

Use to link components together in a single chain. You can link up to 17 different components (including this unit) with this method.

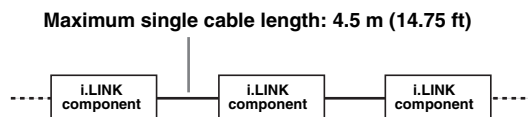

■ Tree connections

Use to link components in a branched configuration when 3 or more i.LINK connectors are available. You can link up to 63 different components (including this unit) with this method.

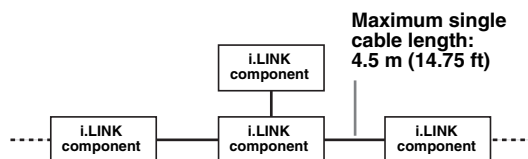

Notes

- When making connections, use a 4-pin IEEE1394 cable that supports the S400 transmission speed. We also recommend using a cable less than 3.5 m (10 ft) in length.
- The system will not work if components are connected in a loop (where the output signal is returned to the original component).
- This unit does not output signals not input at the i.LINK jacks.
- Because the data transfer rates may vary depending on the arrangement order of i.LINK components, it is advised that you link i.LINK components with the same data transfer rates.
- Do not disconnect or connect the IEEE1394 cable from this unit or other i.LINK components while data is being transferred. Doing so may disrupt playback or cause noise.
- When connecting the IEEE1394 cable to this unit's i.LINK connectors, be sure to confirm the orientation of the connector before connecting the cable. Using excessive force to connect the cable to the connector in the wrong orientation will damage the connector.
- Do not turn the power of i.LINK components on or off while data is transferred. Doing so may stop playback. If this happens, turn this unit to standby mode, and then turn it back on.
- Other i.LINK components connected to this unit need to support DTCP (Digital Transmission Content Protection).
- This unit supports i.LINK (AUDIO) components only. Because this unit does not support i.LINK (VIDEO), video signals, such as MPEG2-TS (BS digital, etc.) or DV (DV camera, DVD recorder, etc.), are not compatible with this unit.
- If this unit is in the standby mode or turned off, signals cannot be output to the next i.LINK component.

Basic i.LINK operations

■ Assigning i.LINK components

When an i.LINK component is connected, this unit automatically recognizes the connection and registers up to 16 i.LINK components. Assigning an i.LINK component to a specific input allows you to select video and audio input signals from that component received via the i.LINK connection for simultaneous playback.

Turn on the power of this unit and the connected i.LINK component.

The i.LINK component is automatically recognized and registered in the following order:

DVD → DTV → CBL/SAT → VCR1 → DVR/VCR2 → V-AUX → PHONO → CD → CD-R → MD/TAPE
 “LINK CHECK” flashes on the front panel display during this procedure.

Notes

- If you want to change the input assignment of a registered i.LINK component, use Input Assign in the GUI menu (see page 93) or INPUT ASSIGN in the front panel display system options menu (see page 90).
- Only one i.LINK component is assigned to each input and inputs that are already assigned are skipped.
- If i.LINK components are assigned to all the inputs available, no more i.LINK components can be assigned, and audio signals input from these i.LINK components cannot be played back on this unit.

■ Listening to playback from i.LINK components

If an i.LINK component has been assigned to a specific input, perform the following steps to listen to playback from the registered i.LINK component.

1 Rotate the INPUT selector to select the input assigned to the i.LINK component.

2 Press AUDIO SELECT repeatedly to set “AUTO” or “i.LINK” as the input mode.



or



3 Start playback on the connected i.LINK component.

Notes

- You can turn on/off automatic playback when an i.LINK component is selected using the INPUT selector or to select whether you want the input to switch automatically when an input stream from a connected i.LINK component is detected (see page 93).
- Audio signals input at the i.LINK jacks are digitally output only when AUDIO SELECT is set to either AUTO or i.LINK as the input mode and REC OUT/ZONE 2 on the front panel is set to SOURCE/REMOTE.

Changing i.LINK Select parameters

Use this menu to display information about registered i.LINK components, delete any unused registered components, or customize the operation and playback settings to be used when this unit is connected to an i.LINK component.

1 Switch on this unit and video monitor.

2 Set AMP/SOURCE/TV to AMP, then press TOP on the remote control.

The top display appears.

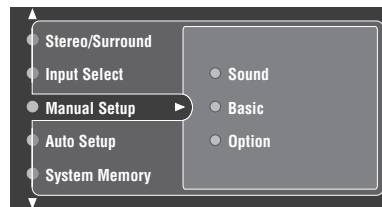
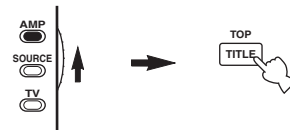

3 Press Δ / ▽ repeatedly to select i.LINK Select.

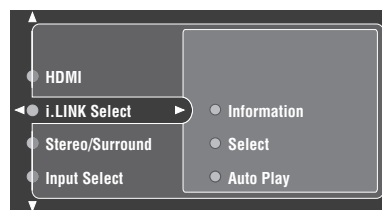

4 Press ENTER or ▷, then press Δ / ▽ repeatedly to change the setting of the item you want to adjust.

5 Press EXIT.

■ Information (Information)

Use this feature to display the following information: operation status of registered i.LINK components, registered i.LINK components that have been deleted, and i.LINK signals that are currently being received.

i.LINK Select > *Information* >

Choices: Details, Delete, Protect, i.LINK Status

- Select Details to display the following information about the selected i.LINK component.
 - **Vendor:** Displays the name of the manufacturer for your i.LINK component.
 - **Model:** Displays the model name of your i.LINK component.
 - **Active** (connected) or **Non Active** (not connected): Displays depending on whether your i.LINK component is connected.
 - **Audio** (for audio signals) or **Non Audio** (for non-audio signals): Displays depending on whether your i.LINK component supports audio signal playback.
 - **Assign:** Displays the name of the input assigned to the selected i.LINK component.
- Select Delete to delete the selected i.LINK component from the registered components list. To delete, press ENTER. You can only delete non-active and unprotected i.LINK components.
- Select Protect to protect the selected i.LINK component from being accidentally deleted.
- Select i.LINK Status to display operation status of i.LINK signals that are currently being received. You can also use this feature to delete all non-active and unprotected i.LINK components together at once.

Note

Information about unregistered i.LINK components is not available in the GUI menu. These i.LINK components cannot be used on this unit although they can be output to other i.LINK components.

■ Select (Input select)

Use this feature to select which registered i.LINK component's audio signal will be selected for playback.

i.LINK Select > *Select* >

Select the name of the desired component and press ENTER to switch the input. When you select the desired component, its manufacturer and model information appear along with its input assignment.

■ Input Assign (Input assign)

Use this feature if you want to change the input assignment of a registered i.LINK component. You can select to assign the i.LINK component to any of the various inputs (PHONO to V-AUX).

i.LINK Select > *Input Assign* >

Choices: PHONO, CD, CD-R, MD/TAPE, DVD, DTV, CBL/SAT, VCR 1, DVR/VCR 2, V-AUX, No Assignment

1 Press Δ / ∇ repeatedly to select the i.LINK component you want to assign, then press \triangleright .

2 Press Δ / ∇ repeatedly to select the input for the i.LINK component, then press ENTER.



This menu item is also available in the front panel display system options menu (see page 90).

■ Auto Play (Auto Play)

Use this feature to turn on/off automatic playback when an i.LINK component is selected using the INPUT selector or to select whether you want the input to switch automatically when an input stream from a connected i.LINK component is detected.

i.LINK Select > *Auto Play* >

Choices: $\leftarrow \leftarrow \rightarrow$ Player, $\rightarrow \rightarrow \rightarrow$ Player, $\leftarrow \leftarrow \leftarrow$ Player, $- X -$ Player

- Select $\leftarrow \leftarrow \rightarrow$ Player if you want both playback to start automatically on the i.LINK component selected using the INPUT selector, and you want this unit to automatically switch its input to the i.LINK component which has started playing back.
- Select $\rightarrow \rightarrow \rightarrow$ Player if you want playback to start automatically on the i.LINK component selected using the INPUT selector.
- Select $\leftarrow \leftarrow \leftarrow$ Player if you want this unit to automatically switch its input to the i.LINK component which has started playing back.
- Select $- X -$ Player to disable automatic playback for the i.LINK components. This setting also prevents this unit from automatically switching its input to the i.LINK component.



This menu item is also available in the front panel display system options menu (see page 90).

i.LINK display messages

■ Status display messages

The following messages may appear on the front panel display depending on the status of this unit.

Message	Contents
LINK CHECK	Flashes while the i.LINK component connection is being checked.*

* Playback may stop while this message is displayed.

■ Error messages

The following messages appear on the front panel display if a connection or registration error is detected.

Message	Cause	Remedy
BUS FULL	The 1394 bus transmission band is full, and no more data can be transmitted.	This problem may be resolved by disconnecting any unused i.LINK components. If an i.LINK component with a slow transmission speed (S100 or S200) is connected between this unit and the i.LINK (AUDIO) component which you want to play back, the bus may become full. Changing the connection order of the i.LINK components so that this unit and the i.LINK (AUDIO) component are directly connected may resolve this problem.
CANNOT LINK	The connected i.LINK component is not recognized because the connection is incomplete.	Check that all i.LINK components are connected properly using an IEEE1394 cable.
LOOP CONNECT	This unit and the i.LINK component are connected in a loop (where the output signal is returned to the original component).	Disconnect the IEEE1394 cable, then reconnect it in either a daisy chain or tree configuration.
NODE OVER	More than 63 i.LINK components (including this unit) are connected.	Reduce the number of connected components.
HOP OVER	More than 15 i.LINK components are connected in a daisy chain configuration.	Reduce the number of i.LINK components connected between the two end components to 15 or less. Reconnect the i.LINK components using tree-type connections.
REGIST. OVER	A new i.LINK component is connected to this unit while 16 i.LINK components are already registered. This unit can register up to 16 i.LINK components.	Delete any unused registered i.LINK components from the registered components list and reconnect the i.LINK component you want to register. See "Changing i.LINK Select parameters" on page 92.

■ i.LINK indicator

Lights up	When an i.LINK component is connected, and this unit is playing back signals input via i.LINK connections.
Flashes	When an i.LINK component is connected, but this unit is playing back signals input via connections other than i.LINK or no signals are being input via i.LINK connections.
Off	When no i.LINK component is connected.

USING HDMI

What is HDMI?

HDMI (High-Definition Multimedia Interface) is the first industry-supported, uncompressed, all-digital A/V (audio/video) interface.

Providing an interface between any A/V source (such as a set-top box or A/V receiver) and an audio/video monitor (such as a digital television – DTV), HDMI supports standard, enhanced or high-definition video as well as multi-channel digital audio using a single cable.

HDMI transmits all ATSC HDTV standards and supports 8-channel digital audio, with bandwidth to spare to accommodate future enhancements and requirements.

When used in combination with HDCP (High-bandwidth Digital Content Protection), HDMI provides a secure audio/video interface that meets the security requirements of content providers and system operators.

For further information on HDMI, visit the HDMI website at “<http://www.hdmi.org/>”.

This unit’s HDMI interface is based on the following standards:

- HDMI 1.1 (High-Definition Multimedia Interface Specification Version 1.1) licensed by HDMI Licensing, LLC.
- HDCP 1.1 (High-bandwidth Digital Content Protection System Revision 1.1) licensed by Digital Content Protection, LLC.

Notes

- Video or audio signals input at audio input jacks other than the HDMI IN 1 or HDMI IN 2 jack cannot be output at the HDMI OUT jack.
- Connect the HDMI OUT jack of other components (such as a DVD player) to the HDMI IN 1 or HDMI IN 2 jack of this unit. Connect the HDMI OUT jack of this unit to the HDMI IN 1 or HDMI IN 2 jack of other components (such as a projector).
- You need a commercially available HDMI cable to connect this unit to other HDMI-compatible components. Use a HDMI cable shorter than 5 m (15 ft) to ensure stable operations and to prevent losses of video quality.
- This unit is not compatible with HDCP-incompatible HDMI or DVI components.
- Use a conversion cable (HDMI jack ↔ DVI-D jack) to connect this unit to other DVI components.
- Digital video signals input at the HDMI IN 1 or HDMI IN 2 jack cannot be output from analog video output jacks.
- GUI displays or analog video signals input at video input jacks cannot be output at the HDMI OUT jack. To display analog video signals, connect them to analog video output jacks.

- Audio signals input at input jacks other than the HDMI IN 1 or HDMI IN 2 of this unit cannot be digitally output at the HDMI OUT jack.
- This unit is not compatible with multi-stereo area audio signals of Super Audio CDs. You can connect devices (such as a DVD player) to the i.LINK jack or the MULTI CH INPUT jacks.
- When connected to a DVD player, audio signals may not be output depending on the type of the DVD player. In case the DVD player connected to this unit does not output DVD multi-channel audio signals at the HDMI OUT jack, connect the DVD player to the i.LINK jack or analog multi-channel audio input jacks.
- When CPPM copy-protected DVD audio plays back, video and audio signals may not be output depending on the type of the DVD player.
- Video and audio signals input at the HDMI IN 1 or HDMI IN 2 jack cannot be output at the HDMI OUT jack when this unit is set to the standby mode or the power is turned off.
- When connecting other HDMI components to this unit, refer to the instruction manuals for those components.
- When HDMI audio signals are output from components like a DVD player, the audio signal format (such as sampling frequencies) may be restricted depending on the HDMI video signal format.
- Do not disconnect or connect the HDMI cable from this unit or turn off the power of the HDMI/DVI components connected to the HDMI OUT jack of this unit while data is being transferred. Doing so may disrupt playback or cause noise.

■ HDMI compatibility with this unit

Audio signal types	Audio signal formats	Compatible HDMI components
2ch Linear PCM	2ch, 32-192 kHz, 16/20/24 bit	CD, DVD-Video, DVD-Audio, etc.
Multi-ch Linear PCM	5.1 ch, 32-96 kHz, 16/20/24 bit	DVD-Audio, etc.
Bitstream	Dolby Digital, DTS	DVD-Video, etc.

Connecting HDMI components

See page 23 for connection information.

HDMI video and audio signal flow

Video or audio signals input at the HDMI IN 1 or HDMI IN 2 jack you selected using Select in the GUI menu (see page 97) or the INPUT selector on the front panel are output at the HDMI OUT jack of this unit. In addition, audio signals input at the HDMI IN 1 or HDMI IN 2 jack are output to speakers, headphones and REC OUT.

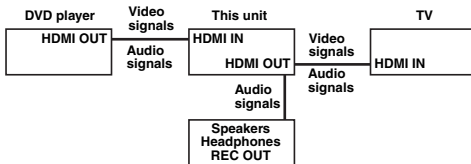

Notes

- Digital audio signals input at the HDMI IN jacks are not output at the analog AUDIO OUT jacks.
- Audio signals input at the HDMI IN 1 or HDMI IN 2 jack are output to REC OUT only when REC OUT/ZONE 2 on the front panel is set to SOURCE/REMOTE. Some audio signals may not be output to REC OUT depending on the signal type.

Connecting HDMI video components

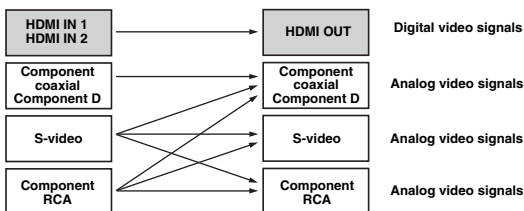

Connecting HDMI audio components

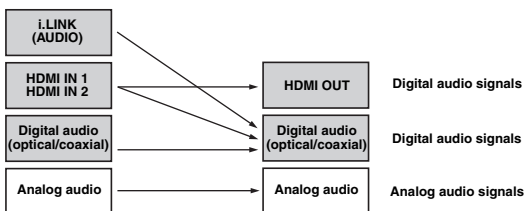

Error messages

In case of an error, an error message appears on the GUI or the front panel display.

Device Over: more than 5 HDMI components (including this unit) are connected. Reduce the number of the connected HDMI components

HDCP Error: HDCP testing failed. Check whether the connected HDMI components support HDCP copy protection standards.

HDMI indicator

Lights up when an HDMI component is connected, and this unit is playing back audio signals input via HDMI.

Flashes when an HDMI component is connected, but this unit is playing back audio signals input via connections other than HDMI or no audio signals are being input via HDMI connections.

Turns off when no HDMI component is connected.

Basic HDMI operations

■ Assigning HDMI components

Assigning an HDMI component to a specific input allows you to select the video input signals from that component together with the audio signals received via the HDMI connection for simultaneous playback.

Note

If you want to change the input assignment of a registered HDMI component, use Input Assign in the GUI menu (see page 98) or INPUT ASSIGN in the front panel display system options menu (see page 90).

■ Listening to playback from HDMI components

Perform the following steps to listen to playback from a registered HDMI component.

If the HDMI component has been assigned to a specific input

1 Rotate the INPUT selector to select the input assigned to the HDMI component.

2 Press AUDIO SELECT repeatedly to set "AUTO" or "HDMI" as the input mode.



or



3 Start playback on the connected HDMI component.

Changing HDMI parameters

You can change HDMI parameters in the GUI or the front panel display menu.

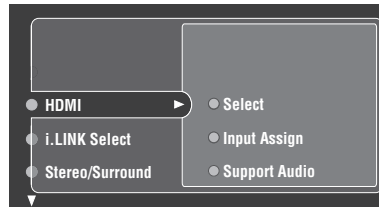

Input Assign and Support Audio are also available in the front panel display system options menu (see page 90). However, Select and Information are only available in the GUI menu.

■ Select (Select)

Use this feature to select the HDMI component assigned to either the HDMI IN or HDMI IN 2 jack of this unit.

HDMI > Select >

Choices: IN 1, IN 2

Select IN 1 or IN 2 to choose the HDMI component assigned to either HDMI input jack.



Note

When the HDMI component connected to the selected HDMI IN jack is not transmitting audio signals (e.g. Super Audio CD or DVI) and AUDIO SELECT is set to AUTO, audio signals input at the analog or other digital input jacks will be selected to playback. It may take a few seconds before this unit outputs sound.

Input Assign (Input assign)

This unit comes with two HDMI IN jacks (HDMI IN 1 and HDMI IN 2). As a default settings, HDMI IN 1 and HDMI IN 2 are assigned to DVD and CBL/SAT respectively, but you may alter these settings if necessary. The same HDMI component cannot be assigned to the HDMI IN 1 and HDMI IN 2 jacks at the same time.

HDMI > Input Assign >

Choices: IN 1, IN 2

Select the HDMI component you want to assign to the HDMI IN 1 or HDMI IN 2 jack.

Assignable HDMI components:

DVD, DTV, CBL/SAT, VCR1, DVR/VCR2, V-AUX



Support Audio (Support audio)

Use this feature to select whether to play back HDMI audio signals on this unit or on another HDMI component connected to the HDMI OUT jack of this unit.

HDMI > Support Audio >

Choices: RX-V4600, Other

- Select RX-V4600 to play back HDMI audio signals on this unit. The audio signals input at the HDMI IN jacks of this unit are not output to the HDMI component connected to the HDMI OUT jack of this unit.
- Select Other to play back HDMI audio signals on another HDMI component connected to the HDMI OUT jack of this unit.

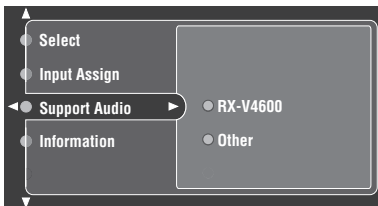

Information (Information)

Use this feature to display information about audio signals input at the HDMI IN jack you selected.

HDMI > Information >

Choices: Input, Output

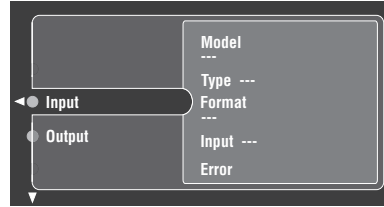

Displaying information about HDMI video signal input

HDMI > Information > Input >

Model: displays the model name of the HDMI component connected to the HDMI IN jack you selected. Some HDMI components may not provide this unit with their model information.

Type: displays the type of video signals (HDMI or DVI) input at the HDMI IN jack you selected.

Format: displays the format of video signals input at the HDMI IN jack you selected.

Input: displays the name of the HDMI IN jack you selected.

Error: displays information about an error.

Displaying information about HDMI video signal output

HDMI > Information > Output >

Model: displays the model name of the component connected to the HDMI OUT jack you selected.

Type: displays the type of component (HDMI or DVI) connected to the HDMI OUT jack.

Error: displays information about an error.

EDITING SOUND FIELD PARAMETERS

What is a sound field?

A significant factor that creates the rich, full tones of a live instrument are the multiple reflections from the walls of the room. In addition to making the sound “live”, these reflections enable us to tell where the player is situated, and the size and shape of the room in which we are sitting.

■ Elements of a sound field

In any environment, in addition to the direct sound coming straight to our ears from the player’s instrument, there are two distinct types of sound reflections that combine to make up the sound field:

Early reflections

Reflected sounds reach our ears extremely rapidly (50 ms – 100 ms after the direct sound), after reflecting from one surface only – for example, from the ceiling or a wall. Early reflections help add clarity to the direct sound.

Reverberations

These are caused by reflections from more than one surface – walls, ceiling, the back of the room – so numerous that they merge together to form a continuous sonic “afterglow”. They are non-directional, and lessen the clarity of the direct sound.

Direct sound, early reflections and subsequent reverberation taken together help us to determine the subjective size and shape of the room, and it is this information that the digital sound field processor reproduces in order to create sound fields.

If you could create the appropriate early reflections and subsequent reverberations in your listening room, you would be able to create your own listening environment. The acoustics in your room could be changed to those of a concert hall, a dance floor, or virtually any size room at all. This ability to create sound fields at will is exactly what YAMAHA has done with the digital sound field processor.

Changing parameter settings

You can enjoy good quality sound with the factory preset parameters. Although you do not have to change the initial settings, you can change some of the parameters to better suit the input source or your listening room. The following parameters are not always found in every program.

- 1 Set AMP/SOURCE/TV to AMP, then press TOP on the remote control.

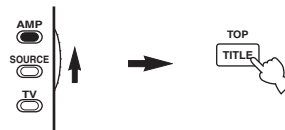

- 2 Select Stereo/Surround, then press \blacktriangleleft .

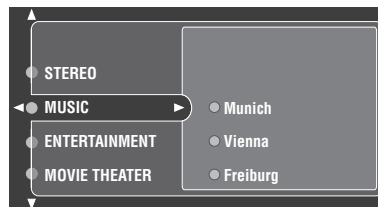

- 3 Select the desired sound field program, then press \blacktriangleright to access and adjust.

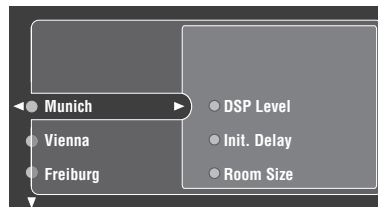

Note

You cannot change parameter values when Memory Guard is set to “On”. If you want to change the parameter values, set Memory Guard to “Off” (see page 68).

Memory back-up

The memory back-up circuit prevents the stored data from being lost even if this unit is set in the standby mode, the power cable is disconnected from the AC outlet, or the power supply is temporarily cut due to power failure. However, if the power is cut for more than one week, the parameter values will return to the factory settings. If this happens, edit the parameter value again.

■ Resetting parameters to the factory values

To reset all parameters

Use Sur.Initialize (see page 67).

SOUND FIELD PARAMETER DESCRIPTIONS

You can adjust the values of certain digital sound field parameters so the sound fields are recreated accurately in your listening room. Not all of the following parameters are found in every program.

■ DSP Level (DSP level)

Function: Adjusts the level of all the DSP effect sounds within a narrow range.

Description: Depending on the acoustics of your listening room, you may want to increase or decrease the DSP effect level relative to the level of the direct sound.

Control Range: -6 dB to +3 dB

■ Init. Delay (Initial delay)

Function: Changes the apparent distance the sound source is from the reflection face by adjusting the delay between the direct sound and the first reflection heard by the listener.

Description: The smaller the value, the closer the reflection face seems to the sound source. The larger the value, the farther it seems. For a small room, set to a small value. For a large room, set to a large value.

Control range: 1 to 99 ms

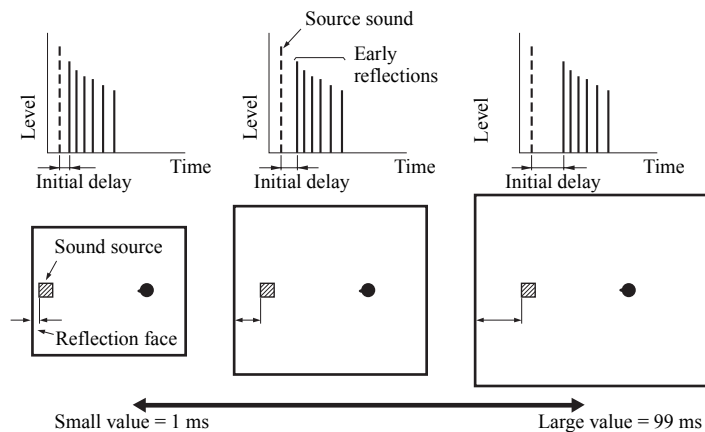

■ Room Size (Room size)

Function: Adjusts the apparent size of the surround sound field. The larger the value, the larger the surround sound field becomes.

Description: As the sound is repeatedly reflected around a room, the larger the hall is, the longer the time between the original reflected sound and the subsequent reflections. By controlling the time between the reflected sounds, you can change the apparent size of the virtual venue. Changing this parameter from one to two, doubles the apparent length of the room.

Control range: 0.1 to 2.0

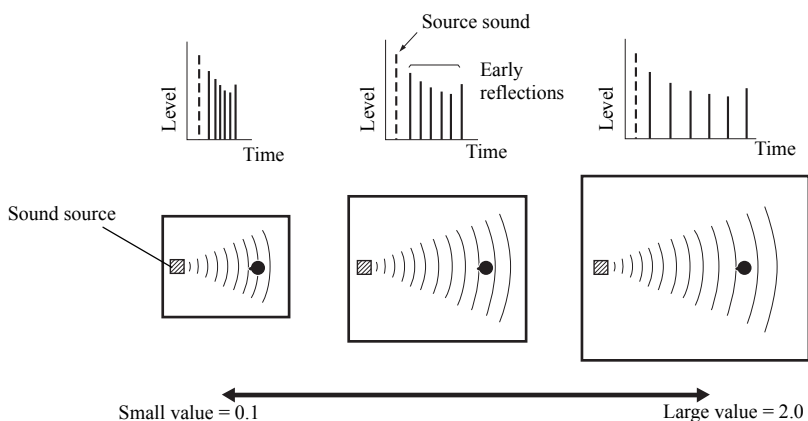

■ Liveness (Liveness)

Function: Adjusts the reflectivity of the virtual walls in the hall by changing the rate at which the early reflections decay.

Description: The early reflections of a source sound decay much faster in a room with acoustically absorbent wall surfaces than in one which has highly reflective surfaces. A room with acoustically absorbent surfaces is referred to as “dead”, while a room with highly reflective surfaces is referred to as “live”. The LIVENESS parameter lets you adjust the early reflection decay rate, and thus the “liveness” of the room.

Control range: 0 to 10

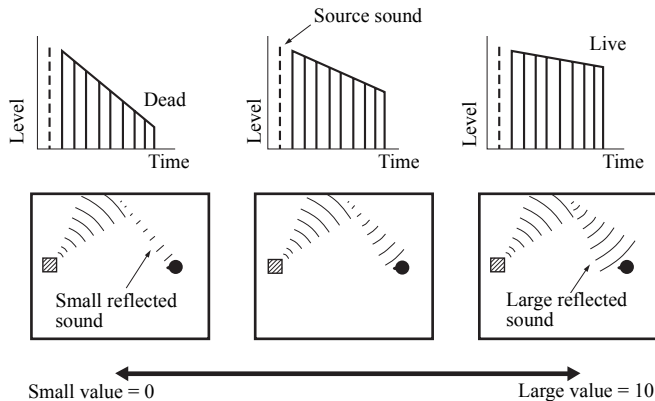

■ Sur.Init.Delay (Surround initial delay)

Function: Adjusts the delay between the direct sound and the first reflection on the surround side of the sound field. You can only adjust this parameter when at least two front channels and two surround channels are used.

Control range: 1 to 49 ms

■ Sur.Room Size (Surround room size)

Function: Adjusts the apparent size of the surround sound field.

Control range: 0.1 to 2.0

■ Sur.Liveness (Surround liveness)

Function: Adjusts the apparent reflectivity of the virtual walls in the surround sound field.

Control range: 0 to 10

■ SB.Init.Delay (Surround back initial delay)

Function: Adjusts the delay between the direct sound and the first reflection in the surround back sound field.

Control range: 1 to 49 ms

■ SB.Room Size (Surround back room size)

Function: Adjusts the apparent size of the surround back sound field.

Control range: 0.1 to 2.0

■ SB.Liveness (Surround back liveness)

Function: Adjusts the apparent reflectivity of the virtual wall in the surround back sound field.

Control range: 0 to 10

■ Rev. Time (Reverberation time)

Function: Adjusts the amount of time it takes for the dense, subsequent reverberation sound to decay by 60 dB (at 1 kHz). This changes the apparent size of the acoustic environment over an extremely wide range.

Description: The longer the reverberation time, the more “live” the listening room environment seems. The shorter the reverberation time, the more “dead” the listening room environment seems.

Control range: 1.0 to 5.0 s

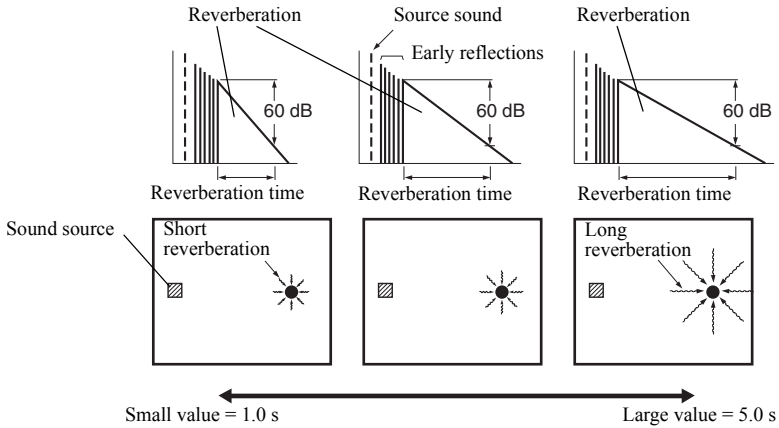

■ Rev. Delay (Reverberation delay)

Function: Adjusts the time difference between the beginning of the direct sound and the beginning of the reverberation sound.

Description: The larger the value, the later the reverberation sound begins. A later reverberation sound makes you feel like you are in a larger acoustic environment.

Control range: 0 to 250 ms

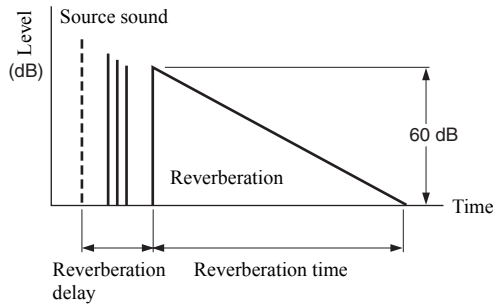

■ Rev. Level (Reverberation level)

Function: Adjusts the volume of the reverberation sound.

Description: The larger the value, the stronger the reverberation becomes.

Control range: 0 to 100%

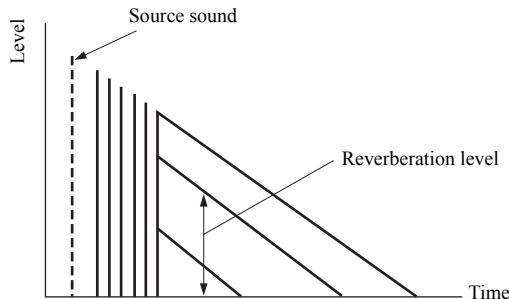

■ Dialogue Lift (Dialog lift)

Function: Adjusts the height of the front and center channel sounds by assigning some of the front and center channel elements to the presence speakers.

Description: The larger the parameter, the higher the position of the front and center channel sound.

Choices: 0, 1, 2, 3, 4, 5

For 7ch Stereo

Function: Adjusts the volume level for each channel in 7-channel stereo mode.

Control range: 0 – 100%

Center Level (Center level)

Surround L Level (Surround left level)

Surround R Level (Surround right level)

Sur. Back Level (Surround back level)

Presence L Level (Presence left level)

Presence R Level (Presence right level)

For PLIIx Music and PLII Music

Panorama (Panorama)

Function: Extends the front stereo image to include the surround speakers for a wraparound effect.

Choices: Off, On

Dimension (Dimension)

Function: Gradually adjusts the sound field either towards the front or towards the rear.

Control range: -3 (towards the rear) to +3 (towards the front), initial setting is STD (standard)

Center Width (Center width)

Function: Adjusts the center image from all three front speakers to varying degrees.

A larger value adjusts the center image towards the front left and right speakers.

Control range: 0 (center channel sound is output only from center speaker) to 7 (center channel sound is output only from front left and right speakers), initial setting is 3

For Neo:6 Music

Center Image (Center image)

Function: Adjusts the center image from all three front speakers to varying degrees.

Control range: 0.0 to 1.0

For SRS Circle Surround II

FOCUS

Function: Adjusts the clearness of a sound image by elevating the perception of the sound image to compensate for non-optimally placed speakers from a lower location.

A larger value makes speakers sound as if they are positioned at ear level.

Control range: 0 to 8

TruBass

Function: Adjusts the lower register by producing the perception of improved low frequency performance.

A larger value improves bass even without a subwoofer and provides deeper, richer bass in the presence of a subwoofer.

Control range: 0 to 8

■ Decode Type (Decoder type)

For MOVIE THEATER

Function: Selects the decoder used to playback 2-channel sources using MOVIE THEATER programs.
Choices: Pro Logic / Pro Logic II / Pro LogicIIx / Neo:6

For THX Cinema

Function: Selects the decoder used to playback 2-channel sources using THX Cinema.
Choices: Pro Logic / Pro Logic II / Pro LogicIIx / Neo:6

For SURROUND Standard

Function: Selects the decoder used to playback 2-channel sources using SURROUND Standard.
Choices: Pro Logic / PLIIMovie / PLIIMusic / PLIIGame / PLIIx Movie / PLIIx Music / PLIIx Game / Neo:6 Cinema / Neo:6 Music / CS II Cinema* / CS II Music* (* U.S.A. model only)

For SURROUND Enhanced

Function: Selects the decoder used to playback 2-channel sources using SURROUND Enhanced.
Choices: Pro Logic / Pro Logic II / Pro LogicIIx / Neo:6

Note

Pro LogicIIx appears when the surround back speakers are available, and Pro Logic II appears when the surround back speakers are not available.

■ Initialize (Initialize)

Function: Initializes the parameters for each sound field subprogram.
Choices: **NO**, YES

Note

If you want to initialize all of the parameters within a sound field program group, use Sur.Initialize (see page 67).

TROUBLESHOOTING

Refer to the chart below when this unit does not function properly. If the problem you are experiencing is not listed below or if the instruction below does not help, set this unit to the standby mode, disconnect the power cable, and contact the nearest authorized YAMAHA dealer or service center.

■ General

Problem	Cause	Remedy	Refer to page
This unit fails to turn on when STANDBY/ ON (or SYSTEM POWER) is pressed, or enters in the standby mode soon after the power has been turned on.	The power cable is not connected or the plug is not completely inserted.	Connect the power cable firmly.	—
	The impedance setting is incorrect.	Set the impedance to match your speakers.	26
	The protection circuitry has been activated.	Make sure all speaker wire connections on this unit and on all speakers are secure and that the wire for each connection does not touch anything other than its respective connection.	15–17
	This unit has been exposed to a strong external electric shock (such as lightning and strong static electricity).	Set this unit in the standby mode, disconnect the power cable, plug it back in after 30 seconds, then use it normally.	—
No sound	Incorrect input or output cable connections.	Connect the cables properly. If the problem persists, the cables may be defective.	18–23
	The optimizer microphone is connected.	Disconnect the optimizer microphone.	—
	The input mode is set to “i.LINK”, “HDMI”, “Coax/Opt” or “Analog”.	Set the input mode to “Auto”.	40
	No appropriate input source has been selected.	Select an appropriate input source with INPUT, MULTI CH INPUT or the input selector buttons on the remote control.	33
	Speaker connections are not secure.	Secure the connections.	15
	The front speakers to be used have not been selected properly.	Select the front speakers by pressing SPEAKERS A or B on the front panel (or by setting AMP/SOURCE/TV to AMP, then pressing SPEAKERS A or B on the remote control).	33
	The volume is turned down.	Turn up the volume.	—
	The sound is muted.	Press MUTE or any operation buttons of this unit to cancel a mute and adjust the volume.	35
	The input mode is set to “Analog” while playing a source encoded with a DTS signal.	Set the input mode to “Auto” or “Coax/Opt”.	40
	The signals this unit cannot reproduce are being received from a source component e.g.: a CD-ROM.	Play a source whose signals this unit can reproduce.	—
	The i.LINK components connected to this unit do not support the DTCP copy protection standards.	Connect i.LINK components that support the DTCP copy protection standards.	—
	The HDMI components connected to this unit do not support the HDCP copy protection standards.	Connect HDMI components that support the HDCP copy protection standards.	—
Support Audio is set to Other and HDMI audio signals are not being played back on this unit.	Set Support Audio to RX-V4600 in the GUI menu.	98	
No picture	The output and input for the picture are connected to different types of video jacks.	Turn on the video conversion function.	66

Problem	Cause	Remedy	Refer to page
The sound suddenly goes off.	The protection circuitry has been activated because of a short circuit, etc.	Check that the impedance selector setting is correct.	26
		Check the speaker wires are not touching each other and then turn this unit back on.	—
	The sleep timer has turned the unit off.	Turn on the power, and play the source again.	—
	The sound is muted.	Press MUTE to cancel a mute.	35
Only the speaker on one side can be heard.	Incorrect cable connections.	Connect the cables properly. If the problem persists, the cables may be defective.	18
	Incorrect balance settings in the GUI menu.	Adjust the Speaker Level settings.	65
Only the center speaker outputs substantial sound.	When playing a monaural source with a CINEMA DSP program, the source signal is directed to the center channel, and the front and surround speakers output effect sounds.		
No sound from the effect speakers	The sound field programs are turned off.	Press STRAIGHT/EFFECT to turn them on.	39
	You are using a source or program combination that does not output sound from all channels.	Try another sound field program.	34
No sound from the center speaker	The output level of the center speaker is set to minimum.	Raise the level of the center speaker.	65
	Center is set to “None” in Speaker Set.	Select the appropriate setting for the center speaker.	62
	One of the HiFi DSP programs (except for 7ch Stereo) has been selected.	Try another sound field program.	34
No sound from the surround speakers	The output level of the surround speakers is set to minimum.	Raise the output level of the surround speakers.	62
	Surround is set to “None” in Speaker Set.	Select the appropriate setting for the surround left and right speakers.	62
	A monaural or stereo source is being played with STRAIGHT.	Press STRAIGHT/EFFECT to turn on the sound fields.	—
No sound from the surround back speakers	Presence speakers are selected.	Select “Surround Back” in PR/SB Select.	61
	Surround is set to “None” in Speaker Set.	If the surround left and right speakers are set to “None”, surround back speakers are automatically set to “None”. Select the appropriate setting for the surround left and right speakers.	62
	Surround Back is set to “None” in Speaker Set.	Select “Small x1”, “Small x2”, “Large x1” or “Large x2”.	63
No sound from the subwoofer	Bass Out is set to “Front” when a Dolby Digital or DTS signal is being played.	Select “SWFR” or “Both”.	63
	Bass Out is set to “SWFR” or “Front” when a 2-channel source is being played.	Select “Both”.	63
	The source does not contain low bass signals.		

Problem	Cause	Remedy	Refer to page
Dolby Digital or DTS sources cannot be played. (Dolby Digital or DTS indicator on the front panel display does not light up.)	The connected component is not set to output Dolby Digital or DTS digital signals.	Make an appropriate setting following the operations instructions for your component.	—
	The input mode is set to “Analog”.	Set the input mode to “Auto” or “Coax/Opt”.	40
A “humming” sound can be heard.	Incorrect cable connections.	Firmly connect the audio plugs. If the problem persists, the cables may be defective.	—
	No connection from the turntable to the GND terminal.	Connect the grounding cord of your turntable to the GND terminal of this unit.	22
The volume level is low while playing a record.	The record is being played on a turntable with an MC cartridge.	The turntable should be connected to this unit through an MC-head amplifier.	22
The volume level cannot be increased, or the sound is distorted.	The component connected to the OUT (REC) jacks of this unit is turned off.	Turn on the power to the component.	—
The sound effect cannot be recorded.	It is not possible to record the sound effect with a recording component.		
A source cannot be recorded by a digital recording component connected to this DIGITAL OUTPUT jack.	The source component is not connected to this unit’s DIGITAL INPUT jacks.	Connect the source component to the DIGITAL INPUT jacks.	18–22
	Some components cannot record the Dolby Digital or DTS sources.		
A source cannot be recorded by an analog component connected to the AUDIO OUT jacks.	The source component is not connected to this unit’s analog AUDIO IN jacks.	Connect the source component to the analog AUDIO IN jacks.	18–22
The sound field parameters and some other settings on this unit cannot be changed.	Memory Guard is set to “On”.	Select “Off”.	68
This unit does not operate properly.	The internal microcomputer has been frozen by an external electric shock (such as lightning or excessive static electricity) or by a power supply with low voltage.	Disconnect the AC power cable from the outlet and then plug it in again after about 30 seconds.	—
“CHECK SP WIRES” appears on the front panel display.	Speaker cables are short circuited.	Make sure all speaker cables are connected correctly.	15
There is noise interference from digital or radio-frequency equipment, or this unit.	This unit is too close to the digital or radio-frequency equipment.	Move this unit further away from such equipment.	—
The picture is disturbed.	The video source uses scrambled or encoded signals to prevent dubbing.		
This unit suddenly enters the standby mode.	The internal temperature becomes too high and the overheat protection circuitry has been activated.	Wait for about 1 hour until this unit cools down and then turn it back on.	—

■ Tuner

Problem		Cause	Remedy	Refer to page
FM	FM stereo reception is noisy.	The characteristics of FM stereo broadcasts may cause this problem when the transmitter is too far away or the antenna input is poor.	Check the antenna connections. Try using a high-quality directional FM antenna.	24
			Use the manual tuning method.	41
	There is distortion, and clear reception cannot be obtained even with a good FM antenna.	There is multipath interference.	Adjust the antenna position to eliminate multipath interference.	—
	The desired station cannot be tuned in with the automatic tuning method.	The signal is too weak.	Use a high-quality directional FM antenna.	24
			Use the manual tuning method.	41
Previously preset stations can no longer be tuned in.	This unit has been disconnected for a long period.	Preset the stations again.	42	
AM	The desired station cannot be tuned in with the automatic tuning method.	The signal is weak or the antenna connections are loose.	Tighten the AM loop antenna connections and orient it for the best reception.	—
			Use the manual tuning method.	41
	There are continuous crackling and hissing noises.	Noises result from lightning, fluorescent lamps, motors, thermostats and other electrical equipment.	Use an outdoor antenna and a ground wire. This will help somewhat, but it is difficult to eliminate all noise.	—
	There are buzzing and whining noises.	A TV set is being used nearby.	Move this unit away from the TV.	—

■ Remote control

Problem	Cause	Remedy	Refer to page
The remote control does not work or function properly.	Wrong distance or angle.	The remote control will function within a maximum range of 6 m (20 ft) and no more than 30 degrees off-axis from the front panel.	9
	Direct sunlight or lighting (from an inverter type of fluorescent lamp, etc.) is striking the remote control sensor of this unit.	Reposition this unit.	—
	The batteries are weak.	Replace all batteries.	4
	AMP/SOURCE/TV is set incorrectly.	Set AMP/SOURCE/TV correctly. When operating this unit, set it to the AMP position. When operating the component selected by the input selector button, set it to the SOURCE position. When operating the TV set in the DTV or PHONO area, set it to the TV position.	—
	The remote control code was not correctly set.	Set the remote control code correctly using “LIST OF REMOTE CONTROL CODES” at the end of this manual.	71
		Try setting another code of the same manufacturer using “LIST OF REMOTE CONTROL CODES” at the end of this manual.	71
	This unit’s library code and the remote control ID do not match.	Switch the library code.	71
Even if the remote control code is correctly set, there are some models that do not respond to the remote control.	Program the necessary functions independently into the programmable buttons using the Learn feature.	73	
The remote control does not “learn” new functions.	The batteries of this remote control and/or the other remote control are too weak.	Replace the batteries.	4
	The distance between the two remote controls is too much or too little.	Place the remote controls at the proper distance.	73
	The signal coding or modulation of the other remote control is not compatible with this remote control.	Learning is not possible.	—
	Memory capacity is full.	Delete other unnecessary functions to make room for the new functions.	78

Audio formats

■ Dolby Digital

Dolby Digital is a digital surround sound system that gives you completely independent multi-channel audio. It provides 5 full-range audio channels; 3 front channels (left, center, and right), and 2 surround stereo channels. An additional channel especially for bass effects, called LFE (low frequency effect) is also provided giving the system a total of 5.1-channels (LFE is counted as a 0.1 channel). By using 2-channel stereo for the surround speakers, more accurate moving sound effects and surround sound environment are possible than with Dolby Surround. The wide dynamic range (maximum to minimum volume) reproduced by the 5 full-range channels and the precise sound orientation generated using digital sound processing provide listeners with a previously unheard of excitement and realism.

■ Dolby Digital EX

Dolby Digital EX creates 6 full-bandwidth output channels from 5.1-channel sources. This is done by using a matrix decoder that derives 3 surround channels from the 2 in the original recording. For best results, Dolby Digital EX should be used with movie sound tracks recorded with Dolby Digital Surround EX. With this additional channel, you can experience more dynamic and realistic moving sound especially with scenes that have “flyover” and “fly-around” effects.

■ Dolby Pro Logic II

Dolby Pro Logic II is an improved technique used to decode vast numbers of existing Dolby Surround software. This new technology enables a 5-channel playback with 2 front left and right channels, 1 center channel, and 2 surround left and right channels (instead of only 1 surround channel for conventional Pro Logic technology). Music and Game modes are also available for 2-channel sources in addition to the Movie mode.

■ Dolby Pro Logic IIx

Dolby Pro Logic IIx is a new technology enabling 6.1 or 7.1 multi-channel playback from 2-channel or multi-channel sources. There is a Music mode for music, a Movie mode for movies and a Game mode for games.

■ Dolby Surround

Dolby Surround uses a 4 channel analog recording system to reproduce realistic and dynamic sound effects: 2 front left and right channels (stereo), a center channel for dialog (monaural), and a surround channel for special sound effects (monaural). The surround channel reproduces sound within a narrow frequency range.

Dolby Surround is widely used with nearly all video tapes and laser discs, and in many TV and cable broadcasts as well. The Dolby Pro Logic decoder built into this unit employs a digital signal processing system that automatically stabilizes the volume on each channel to enhance moving sound effects and directionality.

■ DSD

Direct Stream Digital (DSD) technology stores audio signals on digital storage media, such as Super Audio CDs. Using DSD, signals are stored as single bit values at a high-frequency sampling rate of approximately 2.8224 MHz, while noise shaping and oversampling are used to reduce distortion, a common occurrence with very high quantization of audio signals. Due to the a high sampling rate, better audio quality can be achieved than that offered by the PCM format used for normal audio CDs.

■ DTS 96/24

DTS 96/24 offers an unprecedented level of audio quality for multi-channel sound on DVD-Video, and is fully backward-compatible with all DTS decoders. “96” refers to a 96 kHz sampling rate (compared to the typical 48 kHz sampling rate). “24” refers to 24-bit word length.

DTS 96/24 offers sound quality transparent to the original 96/24 master, and 96/24 5.1-channel sound with full-quality full-motion video for music programs and motion picture soundtracks on DVD-video.

■ DTS (Digital Theater Systems) Digital Surround

DTS digital surround was developed to replace the analog soundtracks of movies with a 6-channel digital sound track, and is now rapidly gaining popularity in movie theaters around the world. Digital Theater Systems Inc. has developed a home theater system so that you can enjoy the depth of sound and natural spatial representation of DTS digital surround in your home. This system produces practically distortion-free 6-channel sound (technically, left, right and center channels, 2 surround channels, plus an LFE 0.1 channel as a subwoofer, for a total of 5.1-channels). This unit incorporates a DTS-ES decoder that enables 6.1- channel reproduction by adding a surround back channel to the existing 5.1-channel format.

■ Neo:6

Neo:6 decodes conventional 2-channel sources for 6 channel playback by. It enables playback with the full-range channels with higher separation comparable to digital discrete signal playback. Two modes are available; “Music mode” for playing music sources and “Cinema mode” for movies.

■ PCM (Linear PCM)

Linear PCM is a signal format under which an analog audio signal is digitized, recorded and transmitted without using any compression. This is used as a method of recording CDs and DVD audio. The PCM system uses a technique for sampling the size of the analog signal per very small unit of time. Standing for “pulse code modulation”, the analog signal is encoded as pulses and then modulated for recording.

■ SRS CS II (SRS Circle Surround II)

SRS CS II (SRS Circle Surround II) is a high-performance 6.1 channel matrix surround sound decoding system. It is the next-generation of the original SRS Circle Surround technology, incorporating powerful industry-first features including the dialog clarity enhancement technology and added cinema-like bass to the front channels and subwoofer.

Sound field programs

■ CINEMA DSP

Since the Dolby Surround and DTS systems were originally designed for use in movie theaters, their effect is best felt in a theater having many speakers and designed for acoustic effects. Since home conditions, such as room size, wall material, number of speakers, and so on, can differ so widely, it's inevitable that there are differences in the sound heard. Based on a wealth of actually measured data, YAMAHA CINEMA DSP uses YAMAHA original sound field technology to combine Dolby Pro Logic, Dolby Digital and DTS systems to provide the visual and audio experience of a movie theater in the listening room of your own home.

■ SILENT CINEMA

YAMAHA has developed a natural, realistic sound effect DSP algorithm for headphones.

Parameters for headphones have been set for each sound field so that accurate representations of all the sound field programs can be enjoyed on headphones.

■ Virtual CINEMA DSP

YAMAHA has developed a Virtual CINEMA DSP algorithm that allows you to enjoy DSP sound field surround effects without any surround speakers by using virtual surround speakers.

It is even possible to enjoy Virtual CINEMA DSP using a minimal two-speaker system that does not include a center speaker.

Audio information

■ ASA (Advanced Speaker Array)

ASA is a proprietary THX technology which processes the sound fed to 2 side and 2 back surround speakers to provide the optimal surround sound experience. When you set up your home theater system using all eight speaker outputs (Left, Center, Right, Surround Right, Surround Back Right, Surround Back Left, Surround Left and Subwoofer) placing the two Surround Back speakers close together facing the front of the room will provide the largest sweet spot. If for practical reasons you have to place the Surround Back speakers apart, you will need to go THX Audio Set-up screen and choose the setting that most closely corresponds to the speaker spacing, which will re-optimized the surround sound-field.

ASA is used in three new modes: THX Select2 Cinema, THX Music Mode and THX Games Mode.

■ ITU-R

ITU-R is the radio communication sector of the ITU (International Telecommunication Union). ITU-R recommends a standard speaker placement which is used in many critical listening rooms, such as mastering studios.

■ LFE 0.1 channel

This channel is for the reproduction of low bass signals. The frequency range for this channel is 20 Hz to 120 Hz. This channel is counted as 0.1 because it only enforces a low frequency range compared to the full-range reproduced by the other 5/6 channels in Dolby Digital or DTS 5.1/6.1-channel systems.

■ Sampling frequency and number of quantized bits

When digitizing an analog audio signal, the number of times the signal is sampled per second is called the sampling frequency, while the degree of fineness when converting the sound level into a numeric value is called the number of quantized bits.

The range of rates that can be played back is determined based on the sampling rate, while the dynamic range representing the sound level difference is determined by the number of quantized bits. In principle, the higher the sampling frequency, the wider the range of frequencies that can be played back, and the higher the number of quantized bits, the more finely the sound level can be reproduced.

■ THX Cinema processing

THX is an exclusive set of standards and technologies established by the world-renowned film production company, Lucasfilm Ltd. THX grew from George Lucas' personal desire to make your experience of the film soundtrack, in both movie theatres and in your home theatre, as faithful as possible to what the director intended.

Movie soundtracks are mixed in special movie theatres called dubbing stages and are designed to be played back in movie theatres with similar equipment and conditions. This same soundtrack is then transferred directly onto Laserdisc, VHS tape, DVD, etc., and is not changed for playback in a small home theatre environment.

THX engineers developed patented technologies to accurately translate the sound from the movie theatre environment into the home, correcting the tonal and spatial errors that occur. On this product, when the THX indicator is on, THX features are automatically added in Cinema modes (e.g. THX Cinema, THX Surround EX).

Adaptive decorrelation

In a movie theatre, a large number of surround speakers help create an enveloping surround sound experience, but in a home theatre there are usually only two speakers. This can make the surround speakers sound like headphones that lack spaciousness and envelopment. The surround sounds will also collapse into the closest speaker as you move away from the middle seating position. Adaptive decorrelation slightly changes one surround channel's time and phase relationship with respect to the other surround channel. This expands the listening position and creates – with only two speakers – the same spacious surround experience as in a movie theatre.

Re-equalization

The tonal balance of a film soundtrack will be excessively bright and harsh when played back over audio equipment in the home because film soundtracks were designed to be played back in large movie theatres using very different professional equipment. Re-equalization restores the correct tonal balance for watching a movie soundtrack in a small home environment.

Timbre matching

The human ear changes our perception of sound depending on the direction from which it is coming. In a movie theatre, there is an array of surround speakers so that the surround information is all around you. In a home theatre, you use only two speakers located to the side of your head. The timbre matching feature filters the information going to the surround speakers so that they more closely match the tonal characteristics of the sound coming from the front speakers. This ensures seamless panning between the front and surround speakers.

■ THX Games Mode

For the replay of stereo and multi-channel game audio the THX Games Mode should be selected. In this mode THX ASA processing is applied to the surround channels of all 5.1 and 2.0 encoded game sources such as analog, PCM, DTS and Dolby Digital. This accurately places all game audio surround information, providing a full 360 degree playback environment. THX Games Mode is unique as it gives you a smooth transition of audio in all points of the surround field.

■ THX Music Mode

For the replay of multi-channel music the THX Music Mode should be selected. In this mode THX ASA processing is applied to the surround channels of all 5.1 encoded music sources such as DTS, Dolby Digital and DVD-Audio to provide a wide stable rear soundstage.

■ THX Select2

Before any home theatre component can be THX Select2 certified, it must incorporate all the features described in THX Cinema processing and also pass a rigorous series of quality and performance tests. Only then can a product feature the THX Select2 logo, which is your guarantee that the Home Theatre products you purchase will give you superb performance for many years to come. THX Select2 requirements cover every aspect of the product including power amplifier and pre-amplifier performance and operation, and hundreds of other parameters in both the digital and analog domain.

■ THX Select2 Cinema mode

THX Select2 Cinema mode plays 5.1 movies using all 8 speakers giving you the best possible movie watching experience. In this mode ASA processing blends the side surround speakers and back surround speakers providing the optimal mix of ambient and directional surround sounds.

DTS-ES (Matrix and 6.1 Discrete) and Dolby Digital Surround EX encoded soundtracks will be automatically detected in THX Select2 Cinema mode if the appropriate flag has been encoded.

Some Dolby Digital Surround EX soundtracks are missing the digital flag that allows automatic switching. If you know that the movie that you are watching is encoded in Surround EX, you can manually select the THX Surround EX playback mode; otherwise, THX Select2 Cinema mode will apply ASA processing to provide optimum replay.

■ THX Surround EX

THX Surround EX-Dolby Digital Surround EX is a joint development of Dolby Laboratories and the THX Ltd.

In a movie theater, film soundtracks that have been encoded with Dolby Digital Surround EX technology are able to reproduce an extra channel which has been added during the mixing of the program. This channel, called Surround Back, places sounds behind the listener in addition to the currently available front left, front center, front right, surround right, surround left and subwoofer channels. This additional channel provides the opportunity for more detailed imaging behind the listener and brings more depth, spacious ambience and sound localization than ever before.

Movies that were created using the Dolby Digital Surround EX technology, when released into the home consumer market may exhibit wording to that effect on the packaging. A list of movies created using this technology can be found on the Dolby web site at www.dolby.com. A list of available DVD software titles encoded with this technology can be found at www.thx.com.

Only receiver and controller products bearing the THX Surround EX logo, when in the THX Surround EX mode, faithfully reproduce this new technology in the home.

This product may also engage the THX Surround EX mode during the playback of 5.1 channel material that is not Dolby Digital Surround EX encoded. In such cases the information delivered to the Surround Back channel will be program dependent and may or may not be pleasing depending on the particular soundtrack and the tastes of the individual listener.

Video signal information

■ Component video signal

With the component video signal system, the video signal is separated into the Y signal for the luminance and the P_B and P_R signals for the chrominance. Color can be reproduced more faithfully with this system because each of these signals is independent. The component signal is also called the “color difference signal” because the luminance signal is subtracted from the color signal. A monitor with component input jacks is required in order to use the component signal for output.

■ Composite video signal

With the composite video signal system, the video signal is composed of three basic elements of a video picture; color, brightness and synchronization data. A composite video jack on a video component transmits these three elements combined.

■ S-video signal

With the S-video signal system, the video signal normally transmitted using a pin cable is separated and transmitted as the Y signal for the luminance and the C signal for the chrominance through the S-video cable. Using the S VIDEO jack eliminates video signal transmission loss and allows recording and playback of even more beautiful images.

PARAMETRIC EQUALIZER INFORMATION

This unit employs YAMAHA Parametric Room Acoustic Optimizer (YPAO) technology, together with the Parametric EQ settings (see page 59), to optimize the frequency characteristics of its parametric equalizer to match your listening environment. YPAO uses a combination of the following three parameters (Frequency, Gain and Q factor) to provide highly precise adjustment of the frequency characteristics.

■ Frequency

This parameter is adjustable in one-third octave increments between 63 Hz and 16 kHz.

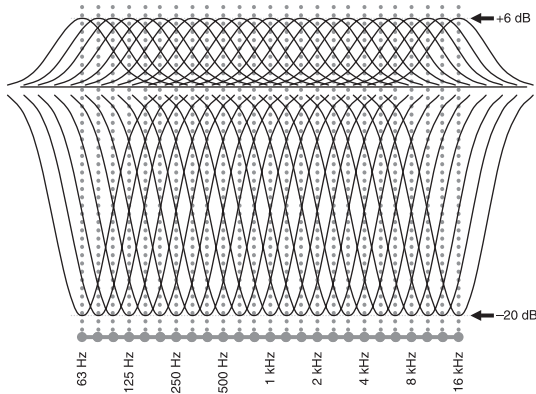

■ Gain

This parameter is adjustable in increments of 0.5 dB between -20 and +6 dB.

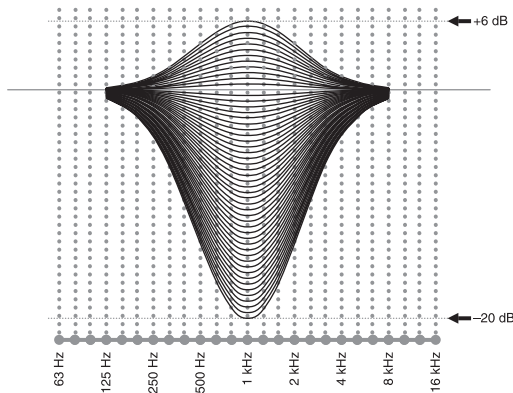

■ Q factor

The width of the specified frequency band is referred to as the Q factor. This parameter is adjustable between the values 0.5 and 10.

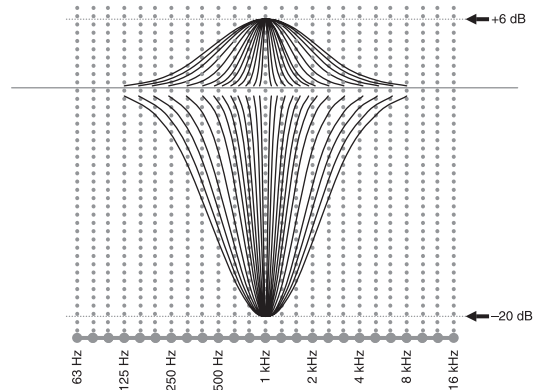

YPAO adjusts frequency characteristics to suit your listening requirements using a combination of the above three parameters (Frequency, Gain and Q factor) for each equalizer band in this unit's parametric equalizer. This unit has 7 equalizer bands for each channel.

The use of multiple equalizer bands enables more precise adjustments of frequency characteristics (as in Figure 2). This is not possible using only a single equalizer band (as in Figure 1).

Figure 1

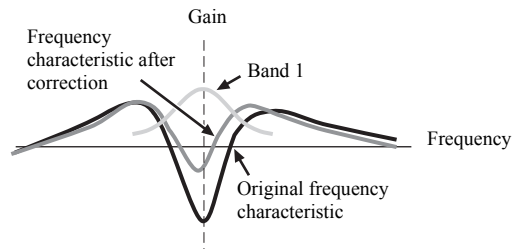
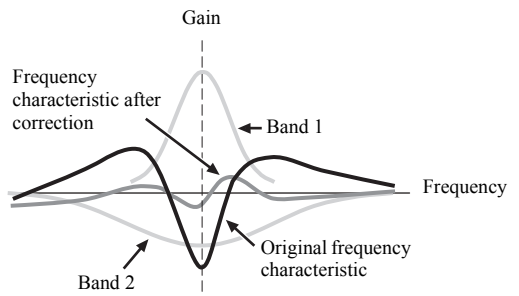

Figure 2



SPECIFICATIONS

AUDIO SECTION

- Minimum RMS Output Power for Front, Center, Surround, Surround back
20 Hz to 20 kHz, 0.04% THD, 8 Ω 130 W
- Maximum Power (EIAJ)
[Asia, General, China and Korea models]
1 kHz, 10% THD, 8 Ω 180 W
- Dynamic Power (IHF)
[U.S.A., Canada, Asia, General, China, Korea and Australia models]
8/6/4/2 Ω 165/205/260/340 W
- DIN Standard Output Power [U.K. and Europe models]
1 kHz, 0.7% THD, 4 Ω 190 W
- Dynamic Headroom
[U.S.A., Canada, Asia, General, China, Korea and Australia models]
8 Ω 1.03 dB
- IEC Output Power [U.K. and Europe models]
1 kHz, 0.04% THD, 8 Ω 140 W
- Damping Factor (IHF)
20 Hz to 20 kHz, 8 Ω 140 or more
- Input Sensitivity/Input Impedance
PHONO 3.5 mV/47 kΩ
CD, etc. 200 mV/47 kΩ
MULTI CH INPUT 200 mV/47 kΩ
- Maximum Input Signal
PHONO (1 kHz, 0.1% THD) 100 mV or more
CD, etc. (1 kHz, 0.5% THD) 2.4 V or more
- Output Level/Output Impedance
REC OUT 200 mV/1.2 kΩ
PRE OUT 1.0 V/500 Ω
SUBWOOFER 2.0 V/500 Ω
ZONE 2/ZONE 3 OUT 1.0 V/1.2 kΩ
[U.S.A., Canada, Australia, U.K. and Europe models]
- Headphone Jack Rated Output/Impedance
CD, etc. (1 kHz, 40 mV, 8 Ω) 150 mV/100 Ω
- Frequency Response
CD to Front L/R 10 Hz to 100 kHz, +0/-3 dB
- RIAA Equalization Deviation
PHONO (20 Hz to 20 kHz) 0 ± 0.5 dB
- Total Harmonic Distortion
PHONO to REC OUT
(20 Hz to 20 kHz, 1 V) 0.02% or less
CD, etc. to Front L/R
(20 Hz to 20 kHz, 65 W, 8 Ω) 0.04% or less
- Signal to Noise Ratio (IHF-A Network)
PHONO (5 mV) to Front L/R
[U.S.A., Canada, Asia, General, China and Korea models]
..... 86 dB or more
[Australia, U.K. and Europe models] 81 dB or more
CD, etc. (250 mV) to Front L/R 100 dB

- Residual Noise (IHF-A Network)
Front L/R 150 μV or less
- Channel Separation (1 kHz/10 kHz)
PHONO (shortened) to Front L/R 60 dB/55 dB or more
CD (5.1 kΩ shortened) to Front L/R 60 dB/45 dB or more
- Tone Control Characteristics (Front L/R)
BASS Boost/Cut ±6 dB/50 Hz
BASS Turnover Frequency 350 Hz
TREBLE Boost/Cut ±6 dB/20 kHz
TREBLE Turnover Frequency 3.5 kHz
- Filter Characteristics (fc=40/60/80/90/100/110/120/160/200 Hz)
H.P.F. (Front, Center, Surround, Surround back) 12 dB/oct.
L.P.F. (Subwoofer) 24 dB/oct.

VIDEO SECTION

- Video Signal Type (Wall Paper)
[Asia, China, Australia, U.K. and Europe models] PAL
[U.S.A., Canada, General and Korea models] NTSC
- Video Signal Type (Video Conversion)
[Asia, General, China, Australia, U.K. and Europe models]
..... PAL
[Other models] NTSC
- Signal Level
Composite 1 Vp-p/75 Ω
S-video 1 Vp-p/75 Ω (Y), 0.286 Vp-p/75 Ω (C)
Component 1 Vp-p/75 Ω (Y), 0.7 Vp-p/75 Ω (Pb/Pr)
- Maximum Input Level 1.5 Vp-p or more
- Signal to Noise Ratio 60 dB or more
- Frequency Response (MONITOR OUT)
Composite, S-video 5 Hz to 10 MHz, -3 dB
Component 5 Hz to 60 MHz, -3 dB

FM SECTION

- Tuning Range
[U.S.A. and Canada models] 87.5 to 107.9 MHz
[Asia and General models] 87.5/87.50 to 108.0/108.00 MHz
[Other models] 87.50 to 108.00 MHz
- Usable Sensitivity (IHF) 1.0 μV (11.2 dBf)
- Selectivity 70 dB
- Signal to Noise Ratio (IHF)
Mono/Stereo 76 dB/70 dB
HD [U.S.A. model only] 80 dB
- Harmonic Distortion (1 kHz)
Mono/Stereo 0.2%/0.3%
HD [U.S.A. model only] 0.03%
- Stereo Separation (1 kHz)
Stereo 42 dB
HD [U.S.A. model only] 70 dB
- Frequency Response
Stereo 20 Hz to 15 kHz, +0.5, -2 dB
HD [U.S.A. model only] 20 Hz to 18 kHz, +0.5, -3 dB
- Antenna Input (unbalanced) 75 Ω

AM SECTION

- Tuning Range
 - [U.S.A. and Canada models] 530 to 1710 kHz
 - [Asia and General models] 530/531 to 1710/1611 kHz
 - [Other models] 531 to 1611 kHz
- Usable Sensitivity 300 μ V/m
- Signal to Noise Ratio (IHF)
 - HD [U.S.A. model only] 80 dB
- Harmonic Distortion (1 kHz)
 - HD [U.S.A. model only] 0.03%
- Stereo Separation (1 kHz)
 - HD [U.S.A. model only] 70 dB
- Frequency Response (20 Hz to 12.5 kHz)
 - HD [U.S.A. model only] +0.5/-3 dB

GENERAL

- Power Supply
 - [U.S.A. and Canada models] AC 120 V, 60 Hz
 - [General model] AC 110/120/220/230-240 V, 50/60 Hz
 - [Asia model] AC 220/230-240 V, 50/60 Hz
 - [China model] AC 220 V, 50 Hz
 - [Korea model] AC 220 V, 60 Hz
 - [Australia model] AC 240 V, 50 Hz
 - [U.K. and Europe models] AC 230 V, 50 Hz
- Power Consumption
 - [U.S.A. and Canada models] 500 W/630 VA
 - [Other models] 500 W
- Standby Power Consumption
 - [U.S.A. and Canada models] 0.2 W or less
 - [General model] (AC 240 V, 50 Hz) 0.33 W or less
 - [Other models] 0.15 W or less
- Maximum Power Consumption [General model only]
 - 6ch, 10% THD 1100 W
- AC Outlets
 - [U.S.A. and Canada models] 2 (Total 100 W/0.8 A maximum)
 - [Australia and U.K. models] 1 (Total 100 W maximum)
 - [Asia and General models] 2 (Total 50 W maximum)
 - [China and Europe models] 2 (Total 100 W maximum)
- Dimensions (W x H x D) 435 x 171 x 438.5 mm
 (17-1/8" x 6-3/4" x 17-1/4")
- Weight 18.0 kg (39.7 lbs)

LIST OF REMOTE CONTROL CODES

CABLE

ABC	0030, 0035
AMERICAST	0926
BELL SOUTH	0926
BIRMINGHAM CABLE COMMUNICATIONS	0303
BRITISH TELECOM	0030
CABLE & WIRELESS	1095
DAERYUNG	0035, 0504, 0904, 1904
DIRECTOR	0503
FILMNET	0470
GENERAL INSTRUMENT	0030, 0303, 0503, 0837, 1095
GOLDSTAR	0171
HAMLIN	0036, 0300
JERROLD	0030, 0303, 0503, 0837
LG	0171
MNET	0470
MEMOREX	0027
MOTOROLA	0303, 0503, 0837, 1133
NLT	1095
NOOS	0844
ONO	1095
PVP STEREO VISUAL MATRIX	0030
PACE	0264, 1087, 1095
PANASONIC	0027, 0035, 0134
PARAGON	0027
PHILIPS	0332, 0344
PIONEER	0171, 0560, 0904, 1904
PULSAR	0027
QUASAR	0027
REGAL	0300, 0306
RUNCO	0027
SAGEM	0844
SAMSUNG	0027, 0171
SCIENTIFIC ATLANTA	0035, 0504, 0904, 1904
SONY	1033
STARCOM	0030
SUPERCABLE	0303
TS	0030
TELE+1	0470
TELEWEST	1095
TORX	0030
TOSHIBA	0027
TRANS PX	0303
UNITED CABLE	0030
ZENITH	0027, 0552, 0926

CD PLAYER

AIWA	0184
ARCAM	0184
AUDIO RESEARCH	0184
AUDIO TON	0184
AUDIOLAB	0184
AUDIOMECA	0184
CAIRN	0184

CALIFORNIA AUDIO LABS

	0056
CARVER	0184, 0206
CYRUS	0184
DKK	0027
DMX ELECTRONICS	0184
DENON	0900
DYNAMIC BASS	0206
EMERSON	0332
FISHER	0206
GENEXXA	0059, 0332
GOODMANS	0332
GRUNDIG	0184
HARMAN/KARDON	0184, 0200
HITACHI	0059
JVC	0099
KENWOOD	0055, 0064
KRELL	0184
LXI	0332
LINN	0184
MCS	0056
MAGNAVOX	0184, 0332
MARANTZ	0056, 0184
MATSUI	0184
MEMOREX	0332
MERIDIAN	0184
MICROMEGA	0184
MIRO	0027
MISSION	0184
MYRYAD	0184
NAD	0027
NSM	0184
NAIM	0184
OPTIMUS	0027, 0059, 0064, 0206, 0332
PANASONIC	0056
PHILIPS	0184
PIONEER	0059, 0332
POLK AUDIO	0184
PROTON	0184
QED	0184
QUAD	0184
QUASAR	0056
RCA	0059, 0206, 0332
REALISTIC	0206
REVOX	0184
ROTEL	0184
SAE	0184
SANSUI	0184, 0332
SANYO	0206
SCOTT	0332
SEARS	0332
SHARP	0064
SIMAUDIO	0184
SONIC FRONTIERS	0184
SONY	0027
SYMPHONIC	0332
TAG MCLAREN	0184
TANDY	0059
TECHNICS	0056
THORENS	0184
THULE	0184
UNIVERSUM	0184
VICTOR	0099
WARDS	0184
YAMAHA	2300, 2301

CD RECORDER

KENWOOD	0653
MARANTZ	0653
PHILIPS	0653
YAMAHA	2400

DVD PLAYER

ACOUSTIC SOLUTIONS	0757
ALBA	0744
AMSTRAD	0740
APEX DIGITAL	0699, 0744, 0782, 0821, 0823, 0857, 1127
BLAUPUNKT	0744
BLUE PARADE	0598
BUSH	0740
CENTREX	0699
CLATRONIC	0815
CYBERHOME	0741
DVD2000	0548
DAEWOO	0811, 0797
DANSAI	0797
DECCA	0797
DENON	0517
DIAMOND	0795
DIGITREX	0699
EMERSON	0618
ENTERPRISE	0618
FISHER	0697
GE	0549, 0744
GO VIDEO	0742
GOLDSTAR	0768
GRADIENTE	0678
GREENHILL	0744
GRUNDIG	0566
HITACHI	0600, 0691
HITEKER	0699
JVC	0585, 0650
KLH	0744
KENWOOD	0517, 0561
KOSS	0678
LG	0768
LIMIT	0795
MAGNAVOX	0530, 0702
MARANTZ	0566
MEMOREX	0858
MICO	0750
MICROSOFT	0549
MINTEK	0744
MITSUBISHI	0548
MUSTEK	0757
NESA	0744
ONKYO	0530
ORITRON	0678
PALSONIC	0699
PANASONIC	0517, 0659, 1389
PHILIPS	0530, 0566, 0673, 0881
PIONEER	0552, 0598, 0658, 0659
POLK AUDIO	0566
PROSCAN	0549
QWESTAR	0678
RCA	0549, 0598, 0744
ROTEL	0650

SM ELECTRONIC	0757
SAMSUNG	0600
SANYO	0697
SHARP	0657
SHERWOOD	0797
SHINSONIC	0560
SLIM ART	0811
SONY	0560, 0891
SYLVANIA	0702
TATUNG	0797
TEAC	0598, 0744
TECHNICS	0517
THETA DIGITAL	0598
THOMSON	0549
TOSHIBA	0530
URBAN CONCEPTS	0530
XBOX	0549
YAMAHA	0517, 0566, 0572, 2100, 2101, 2102
ZENITH	0530, 0618, 0768
ZEUS	0811

DVD RECORDER

PANASONIC	2800, 2801, 2802
PHILIPS	2808
PIONEER	2804, 2805, 2806
TOSHIBA	2803
YAMAHA	2807

LD PLAYER

CARVER	0091
DENON	0086
MARANTZ	0091
MITSUBISHI	0086
NAD	0086
NAGSMI	0086
OPTIMUS	0086
PHILIPS	0091
PIONEER	0086
SALORA	0091
SONY	0228
TELEFUNKEN	0086
YAMAHA	2200

MD RECORDER

KENWOOD	0708
ONKYO	0895
SHARP	0888
SONY	0517
YAMAHA	2500, 2501, 2502

RECEIVER (TUNER)

ADC	0558
AIWA	0185, 1116, 1415, 1432, 1668
ALCO	1417
ANAM	1636
APEX DIGITAL	1284
AUDIOLAB	1216
AUDIOTRONIC	1216
AUDIOVOX	1417
BOSE	1256
CAMBRIDGE SOUNDWORKS	1397

CAPETRONIC 0558
 CARVER 1116, 1216
 CENTREX 1284
 DENON 1387
 FERGUSON 0558
 FINE ARTS 1216
 GRUNDIG 1216
 HARMAN/KARDON
 0137, 1331
 INTEGRA 0162, 1325
 JBL 0137, 1333
 JVC 0101, 0558, 1401,
 1522
 1417, 1439
 KENWOOD 1054, 1340
 MCS 0066
 MAGNAVOX 0558, 1116, 1216,
 1296,
 MARANTZ 0066, 1116, 1216,
 1316
 MICROMEGA 1216
 MUSICMAGIC 1116
 MYRYAD 1216
 NAD 0347
 NORCENT 1416
 ONKYO 0162, 0869, 1325
 OPTIMUS 0558, 1050
 PANASONIC 0066, 1315, 1545,
 1790
 PHILIPS 1116, 1216, 1293,
 1295, 1296, 1310,
 1316
 PIONEER 0041, 0558, 1050,
 1411
 POLK AUDIO 1316
 PROSCAN 1281
 QUASAR 0066
 RCA 0558, 1050, 1281,
 1417, 1636,
 SABA 0558
 SANSUI 1116
 SCHNEIDER 0558
 SONY 0185, 1085, 1185,
 1685, 1785
 STEREOPHONICS 1050
 SUNFIRE 1340
 TEAC 1417
 TECHNICS 0066, 1335, 1336,
 1545
 TELEFUNKEN 0558
 THOMSON 1281
 THORENS 1216
 UHER 0558
 VENTURER 1417
 VICTOR 0101
 WARDS 0041, 0185
 YAMAHA 0203, 1203, 1358,
 2600, 2601, 2602,
 2603

SATELLITE TUNER

@SAT 1327
 ABSAT 0150
 ALBA 0482
 ALPHASTAR 0799
 AMSTRAD 0874
 ASTON 0169, 1156
 ASTRO 0200
 ATSAT 1327
 AVALON 0423

BLAUPUNKT 0200
 BRITISH SKY BROADCASTING
 0874, 1202
 CANAL DIGITAL 0880
 CANAL SATELLITE 0880
 CANAL+ 0880
 CHAPARRAL 0243
 CITYCOM 1203
 CONNEXIONS 0423
 CROSSDIGITAL 1136
 CYRUS 0227
 D-BOX 0750, 1154
 DMT 1102
 DNT 0227, 0423
 DAERYUNG 0423
 DAEWOO 1323
 DIGENIUS 0326
 DIRECTV 0274, 0419, 0593,
 0666, 0751, 0776,
 0846, 1103, 1136,
 1169, 1776, 1883
 DISH NETWORK SYSTEM
 0802, 1032
 DISHPRO 0802, 1032
 DISTRATEL 0111
 DREAM MULTIMEDIA
 1264
 ECHOSTAR 0194, 0423, 0637,
 0802, 0880, 0898,
 1032, 1113
 ENGEL 1044
 EXPRESSVU 0802
 FTE 0890
 FINLUX 0482
 FRACARRO 0898
 FUBA 0423
 GE 0593
 GOI 0802
 GALAXIS 0890, 1138
 GENERAL INSTRUMENT
 0896
 GOLD BOX 0880
 GRUNDIG 0200, 0874
 HTS 0802
 HIRSCHMANN 0200, 0423
 HITACHI 0482, 0846
 HUGHES NETWORK SYSTEM
 0776, 1169, 1776
 HUMAX 0890, 1203
 INVIDEO 0898
 JVC 0802
 KATHREIN 0150, 0200, 0227,
 0276, 0685, 1248
 KREISELMEYER 0200
 LABGEAR 1323
 LOGIX 1044
 LORENZEN 0326
 MAGNAVOX 0749, 0751
 MANHATTAN 0482, 1044,
 1110
 MARANTZ 0227
 MEDIASAT 0880
 MEMOREX 0751
 METRONIC 0111
 MITSUBISHI 0776
 MOTOROLA 0896
 MYRYAD 0227
 NEXT LEVEL 0896
 NOKIA 0482, 0750, 0778,
 1154, 1250, 1750
 OCTALTV 1032

ORBITECH 1127
 PACE 0482, 0874, 1202,
 1350
 PANASONIC 0274, 0728, 0874,
 1347
 PANDA 0482
 PAYSAT 0751
 PHILIPS 0160, 0227, 0482,
 0749, 0751, 0776,
 0880, 1103, 1169,
 1776
 PIONEER 0880
 PROMAX 0482
 PROSCAN 0419, 0593
 RCA 0170, 0419, 0593,
 0882
 RFT 0227
 RADIOSHACK 0896
 RADIOLA 0227
 RADIX 0423
 SKY 0874, 0883, 1202
 SM ELECTRONIC 1227
 SABRE 0482
 SAGEM 0847, 1141, 1280
 SAMSUNG 1044, 1136, 1303,
 1319
 SAT CONTROL 1327
 SATSTATION 1110
 SCHWAIGER 1138
 SEEMANN 0423
 SIEMENS 0200
 SONY 0666, 0874, 1666
 STAR CHOICE 0896
 STRONG 1327
 TPS 0847, 1280
 TANTEC 0482
 TECHNISAT 1126, 1127
 TELESTAR 1127
 THOMSON 0482, 0880, 1073,
 1318
 TOPFIELD 1233
 TOSHIBA 0776, 0817, 1776
 ULTIMATETV 0419, 0666
 UNIDEN 0749, 0751
 UNIVERSUM 0200
 VENTANA 0227
 WISI 0200, 0423, 0482
 XSAT 0150
 ZEHNDRER 1102
 ZENITH 0883, 1883

TAPE DECK

AIWA 0056
 CARVER 0056
 GRUNDIG 0056
 HARMAN/KARDON
 0056
 MAGNAVOX 0056
 MARANTZ 0056
 MYRYAD 0056
 OPTIMUS 0054
 PHILIPS 0056
 PIONEER 0054
 POLK AUDIO 0056
 RCA 0054
 REVOX 0056
 SANSUI 0056
 SONY 0270
 THORENS 0056
 WARDS 0054
 YAMAHA 2700,2701

TV

AGB 0543
 AOC 0036, 0057, 0087,
 0119, 0120, 0135,
 0205, 0207, 0478
 0131
 ASA 0131
 AWA 0036
 ACURA 0036
 ADDISON 0119, 0135, 0680
 ADMIRAL 0120, 0190, 0490
 ADVENT 0788
 AIKO 0119
 AKAI 0036, 0057, 0235,
 0388, 0543, 0729,
 0839
 AKURA 0291
 ALBA 0036, 0064, 0398,
 0695
 AMERICA ACTION 0207
 AMPRO 0778
 AMSTRAD 0036, 0064, 0198,
 0398, 0439, 0460,
 0543
 ANAM 0036, 0207, 0277
 ANAM NATIONAL 0277, 0677
 ANITECH 0036
 APEX DIGITAL 0775, 0792,
 0794
 AUDIOSONIC 0064, 0136
 BANG & OLUFSEN 0592
 BASIC 0036
 BAUR 0064, 0388, 0539
 BAYSONIC 0207
 BEAUMARK 0205
 BEKO 0397, 0513, 0741,
 0742
 BELL & HOWELL 0181
 BEON 0064
 BLAUPUNKT 0222
 BLUE SKY 0695, 1064
 BONDSTEC 0274
 BRADFORD 0207
 BRANDT 0136, 0362
 BROKSONIC 0263, 0490
 BUSH 0036, 0064, 0398,
 0401, 0695, 1064
 CCE 0064
 CGE 0274
 CTC 0274
 CXC 0207
 CANDLE 0057
 CARNIVALE 0057
 CARVER 0081, 0197
 CASCADE 0036
 CATHAY 0064
 CELEBRITY 0027
 CELERA 0792
 CENTURION 0064
 CHANGHONG 0792
 CHING TAI 0036, 0119
 CHUN YUN 0027, 0036, 0119,
 0207
 CHUNG HSIN 0080, 0135, 0207
 CIMLINE 0036
 CINERAL 0119, 0478
 CITIZEN 0057, 0087, 0119
 CLARION 0207
 CLARIVOX 0064
 CLATRONIC 0274, 0397
 CONDOR 0347, 0397
 CONRAC 0835

CONTEC	0036, 0207	GRANADA	0064, 0235, 0366,	MAGNADYNE	0274, 0543	PHILIPS	0027, 0057, 0064,
CRAIG	0207		0543	MAGNAFON	0543		0078, 0081, 0119,
CROSLEY	0081	GRANDIN	0637	MAGNAVOX	0057, 0081, 1281,		0135, 0205, 0401,
CROWN	0036, 0064, 0207,	GRUNDIG	0064, 0222, 0514,		1481		0583, 0717, 1481
	0397, 0445		0583, 0614	MANESTH	0291, 0347	PHONOLA	0064
CURTIS MATHES	0057, 0074,	GRUNPY	0207	MARANTZ	0057, 0064, 0081,	PILOT	0057
	0081, 0087, 0120,	HCM	0036, 0439		0583	PIONEER	0136, 0190, 0193,
	0172, 0181, 0193,	HALLMARK	0205	MARK	0064		0314, 0706, 0787,
	0478, 0729, 1174,	HANKOOK	0057, 0205, 0207	MATSUI	0036, 0064, 0235,		0893
	1374	HANSEATIC	0064, 0347, 0388,		0398, 0514, 0543	PORTLAND	0119
DAEWOO	0036, 0057, 0064,		0455, 0583	MATSUSHITA	0277, 0677	PRANDONI-PRINCE	0543
	0119, 0135, 0181,	HANTAREX	0543	MEDIATOR	0064		0788
	0197, 0205, 0207,	HARMAN/KARDON	0081	MEDION	0695, 0835, 1064	PRIMA	0788
	0401, 0478, 0650,	HARVARD	0207	MEGATRON	0172, 0205	PRISM	0078
	0661, 1688	HAVERMY	0120	MEMOREX	0036, 0177, 0181,	PROFEX	0036, 0388
DANSAI	0064	HELLO KITTY	0478		0205, 0277, 0490,	PROSCAN	0074
DAYTON	0036	HINARI	0036, 0064		1064	PROTECH	0036, 0064, 0274,
DE GRAAF	0235, 0575	HISAWA	0482	METZ	0474		0291, 0445, 0695
DECCA	0064, 0543	HITACHI	0036, 0057, 0119,	MICROMAXX	0835	PROTON	0036, 0057, 0205
DENON	0172		0132, 0136, 0172,	MICROSTAR	0835	PULSAR	0044
DIGATRON	0064		0190, 0205, 0252,	MIDLAND	0044, 0074, 0078	QUASAR	0078, 0277, 0677
DIXI	0036, 0064		0383, 0508, 0575,	MINERVA	0514	QUELLE	0064, 0131, 0388,
DUMONT	0044		0605, 1172, 1283	MINOKA	0439		0539
DWIN	0747, 0801	HUA TUN	0036	MITSUBISHI	0057, 0120, 0135,	R-LINE	0064
ECE	0064	HUANYU	0401		0177, 0181, 0205,	RCA	0027, 0057, 0074,
ELBE	0286	HYPSON	0064, 0291		0207, 0263, 0277,		0117, 0119, 0205,
ELECTROBAND	0027	ICE	0291, 0398		0539, 0863, 1277		0706, 1074, 1174,
ELIN	0064, 0575	ITS	0398	MIVAR	0318, 0319, 0543,		1274, 1374, 1474,
ELITE	0347	ITT	0190, 0388, 0575		0636		1481, 1574
ELTA	0036	IMPERIAL	0274, 0397, 0445	MOTOROLA	0120	RFT	0455
EMERSON	0181, 0205, 0207,	INDIANA	0064	MULTITECH	0036, 0207	RADIOSHACK	0057, 0074,
	0263, 0388, 0490,	INFINITY	0081	MYRYAD	0583		0181, 0205, 0207
	0650	INGELEN	0190	NAD	0183, 0205, 0388,	RADIOLA	0064
ENVISION	0057, 0840	INNO HIT	0543		0893	RADIOMARELLI	0543
EPSON	0860	INNOVA	0064	NEC	0036, 0057, 0078,	REALISTIC	0057, 0181, 0205,
ERRES	0064	INTEQ	0044		0181, 0183, 0197,		0207
ETHER	0036, 0057	INTERFUNK	0064, 0190, 0274,		0205, 0482, 0524,	REDIFFUSION	0388
ETRON	0036		0388, 0539		1731	REOC	0741
EUROPHON	0543	INTERVISION	0064, 0291,	NEI	0064	REVOX	0064
FERGUSON	0064, 0100, 0136,		0404	NTC	0119	REX	0190, 0286, 0291
	0265, 0314, 0362,	JBL	0081	NECKERMANN	0064, 0583	ROADSTAR	0036, 0291, 0445
	0587	JCB	0027	NETSAT	0064	RUNCO	0044, 0057, 0524,
FIDELITY	0388	JVC	0080, 0398, 0490,	NEWAVE	0036, 0119, 0120,		0630
FINLANDIA	0235, 0373		0680, 0710		0205	SBR	0064
FINLUX	0064, 0131, 0132,	JEAN	0036, 0078, 0119,	NIKKAI	0064, 0291	SEG	0291, 0695
	0373, 0543		0183, 0263	NIKKO	0057, 0119, 0205	SEI	0543
FIRSTAR	0036, 0263	JENSEN	0788	NOKIA	0388, 0500, 0507,	SKY	0064
FIRSTLINE	0036, 0274, 0695	KEC	0207		0575, 0658	SSS	0207
FISHER	0131, 0181, 0235,	KTV	0057, 0207	NORCENT	0775, 0851	SABA	0136, 0190, 0314,
	0397	KAISUI	0036				0362
FLINT	0482	KAPSCH	0190	NORDMENDE	0136, 0314,		0265
FORMENTI	0064, 0347	KARCHER	0637		0587	SACCS	0265
FORTRESS	0120	KATHREIN	0583	OCEANIC	0190, 0388	SAGEM	0637
FRONTECH	0190, 0274, 0291	KENDO	0064	ONWA	0207, 0460	SAISHO	0036, 0291, 0543
FUJITSU	0710, 0836	KENWOOD	0057	OPTIMUS	0181, 0193, 0277,	SALORA	0190, 0380, 0388,
FUNAI	0207, 0198, 0291	KNEISSEL	0286, 0462		0677		0575
FUTURETECH	0207	KOLIN	0080, 0135, 0207	OPTONICA	0120	SAMBERS	0543
GE	0057, 0074, 0078,	KORPEL	0064	ORION	0064, 0263, 0347,	SAMPO	0036, 0057, 0119,
	0119, 0205, 0207,	KOYODA	0036		0490, 0543		0120, 0181, 0198,
	0478, 0587, 1174,	L&S ELECTRONIC	0835	OSAKI	0291, 0439	SAMSUNG	0205, 0677, 1782
	1374, 1481	LG	0057, 0064, 0087,	OTTO VERSAND	0064, 0347,		0036, 0057, 0064,
GEC	0064, 0543		0135, 0205, 0741		0539, 0583		0087, 0117, 0119,
GATEWAY	1782, 1783	LXI	0074, 0081, 0181,	PALLADIUM	0397, 0445		0181, 0205, 0291,
GELOSO	0036		0183, 0205	PANAMA	0291		0397, 0583, 0614,
GENEXXA	0190	LEYCO	0064, 0291	PANASONIC	0064, 0078, 0081,		0645, 0729, 0793,
GIBRALTER	0044, 0057	LOESENK & TTER	0064		0190, 0277, 0677,		0839, 0841
GOLDSTAR	0057, 0064, 0136,	LOEWE	0539	PATHE CINEMA	0265, 0347	SANSEI	0478
	0181, 0205, 0404	LUXOR	0383, 0388	PAUSA	0036	SANSUI	0490
GOODMANS	0064, 0398, 0401,	M ELECTRONIC	0036, 0064,	PENNEY	0057, 0074, 0078,	SANYO	0131, 0181, 0207,
	0661		0131, 0132, 0136,		0087, 0183, 0205,		0235, 0366, 0826
GOREMJE	0397		0190, 0314, 0373,		1374	SCHAUB LORENZ	0388
GRADIENTE	0080, 0197		0401, 0507	PERDIO	0347	SCHNEIDER	0064, 0274, 0398,
GRAETZ	0190, 0388	MGA	0057, 0177, 0205	PHILCO	0057, 0064, 0081,	SCOTCH	0205
		MTC	0057, 0087, 0539		0172, 0205, 0207,	SCOTT	0205, 0207, 0263
					0274, 0490, 1688		

SEARS	0074, 0081, 0181, 0183, 0198, 0205	UHER	0347	CRAIG	0064, 0074, 0099, 0267	KENWOOD	0068, 0094
SELECO	0190, 0286	UNIVERSUM	0064, 0131, 0132, 0291, 0373, 0397, 0519	CROWN	0099, 0305	KODAK	0062, 0064
SEMIVOX	0207			CURTIS MATHES	0062, 0068, 0087, 1062	KOLIN	0068, 0070
SEMP	0183	VECTOR RESEARCH				KORPEL	0099
SHARP	0057, 0120, 0677		0057	CYBERNEX	0267	LG	0064, 0069, 0072, 0507
SHEN YING	0036, 0119	VESTEL	0064	CYRUS	0108	LXI	0064
SHENG CHIA	0036, 0120, 0263	VICTOR	0080, 0277, 0677, 0680	DAEWOO	0072, 0131, 0305, 0669, 1305	LENCO	0305
SIAREM	0543			DANSAI	0099	LEYCO	0099
SIEMENS	0064, 0222	VIDEOSAT	0274	DE GRAAF	0069	LLOYD'S	0027
SINUDYNE	0543	VIDIKRON	0081	DECCA	0027, 0108	LOEWE	0064, 0108, 1589
SKANTIC	0383	VIDTECH	0205	DENON	0069	LOGIK	0099, 0267
SKYGIANT	0207	VIEWSONIC	1782	DUAL	0068	LUXOR	0070, 0075, 0131
SKYWORTH	0064	VISION	0347	DUMONT	0027, 0108, 0131	M ELECTRONIC	0027
SOLAVOX	0190	VOXSON	0190	DYNATECH	0027	MEI	0062
SONITRON	0235	WALTHAM	0383	ESC	0267, 0305	MGA	0070, 0267
SONOKO	0036, 0064	WARDS	0057, 0081, 0205, 0893	ELCATECH	0099	MGN TECHNOLOGY	0267
SONOLOR	0190, 0235			ELECTROHOME	0064	MTC	0027, 0267
SONTEC	0064	WATSON	0064, 0347	ELECTROPHONIC	0064	MAGNASONIC	1305
SONY	0027, 0677, 0861, 1127, 1532, 1678	WAYCON	0183	EMEREX	0059	MAGNAVOX	0027, 0062, 0066, 0108, 1808
SOUNDESIGN	0205, 0207	WHITE WESTINGHOUSE	0064, 0347, 0490, 0650	EMERSON	0027, 0062, 0064, 0070, 0072, 0211, 0267, 0305, 1305, 1506	MAGNIN	0267
SOUNDWAVE	0064, 0445			FERGUSON	0068, 0347	MANESTH	0072, 0099
SOWA	0078, 0087, 0119, 0183, 0205	YAMAHA	0057, 0796, 0860, 2900 (projector), 2901 (projector), 2902	FIDELITY	0027	MARANTZ	0062, 0108
SQUAREVIEW	0198			FINLANDIA	0108, 0131	MARTA	0064
STANDARD	0036	YAPSHE	0277	FINLUX	0027, 0069, 0108, 0131	MATSUI	0375, 0379
STARLITE	0207	YOKO	0064, 0291	FIRSTLINE	0064, 0070, 0072, 0099	MATSUSHITA	0062
STERN	0190, 0286	ZENITH	0044, 0119, 0205, 0490	FISHER	0074, 0131	MEDION	0375
SUPREME	0027			FUJI	0060, 0062	MEMOREX	0027, 0062, 0064, 0066, 0074, 0075, 0131, 0267, 0334, 0375, 1264
SYLVANIA	0057, 0081, 0198			FUJITSU	0027, 0072	MEMPHIS	0099
SYMPHONIC	0198, 0207			FUNAI	0027	METZ	0064, 0374, 1589
SYNCO	0027, 0087, 0119, 0120, 0205, 0478			GE	0062, 0087, 0267, 0834, 1062, 1087	MINOLTA	0069
				GEC	0108	MITSUBISHI	0068, 0070, 0094, 0108, 0834
SYSLINE	0064			GARRARD	0027	MOTOROLA	0062, 0075
T + A	0474	ASA	0064, 0108	GENERAL	0072	MULTITECH	0027, 0099
TCM	0835	ADMIRAL	0075	GO VIDEO	0459	MURPHY	0027
TMK	0205	ADVENTURA	0027	GOLDHAND	0099	MYRYAD	0108
TNCI	0044	AIKO	0305	GOLDSTAR	0064, 0252, 0507, 1264	NAD	0131
TVS	0490	AIWA	0027, 0064, 0334, 0375, 0379	GOODMANS	0027, 0064, 0099, 0305	NEC	0062, 0064, 0068, 0075, 0094, 0131
TACICO	0036, 0119, 0205	AKAI	0068, 0342	GRADIENTE	0027	NATIONAL	0253
TAI YI	0036	AKIBA	0099	GRAETZ	0068, 0131, 0267	NECKERMANN	0108
TANDY	0120, 0190	AKIBA	0099	GRANADA	0108, 0131	NESCO	0099
TASHIKO	0119, 0677	ALBA	0099, 0305, 0342, 0379	GRANDIN	0027, 0064, 0099	NEWAVE	0064
TATUNG	0036, 0064, 0078, 0081, 0087, 0181, 0183, 0543	AMERICA ACTION	0305	GRUNDIG	0099, 0108, 0253, 0374	NIKKO	0064
		AMERICAN HIGH	0062	HCM	0099	NOBLEX	0267
TEAC	0036, 0064, 0291, 0439, 0445, 0482, 0695, 1064	AMSTRAD	0027	HI-Q	0074	NOKIA	0068, 0131, 0267
		ANAM	0064, 0253, 0267, 0305, 0507	HANSEATIC	0064	NORDMENDE	0068, 0347
TEC	0274	ANAM NATIONAL	0253, 1589	HARLEY DAVIDSON	0027	OCEANIC	0027, 0068
TECHNEMA	0347	ANITECH	0099	HARMAN/KARDON	0108	OKANO	0342, 0375
TECHNICS	0078, 0277, 0677	ASHA	0267	HARWOOD	0099	OLYMPUS	0062, 0253
TECHWOOD	0078	ASUKA	0064	HINARI	0099, 0267, 0379	OPTIMUS	0064, 0075, 0131, 0459
TECO	0036, 0078, 0119, 0120, 0205, 0291, 0680	AUDIOVOX	0064, 0305	HITACHI	0027, 0064, 0068, 0069, 0267	ORION	0211, 0375, 0379, 1506
		BAIRD	0027, 0068, 0131	HUGHES NETWORK SYSTEMS	0069	OSAKI	0027, 0064, 0099
TEKNIKA	0081, 0087, 0119, 0177, 0207	BASIC LINE	0099, 0305	HYPSON	0099	OTTO VERSAND	0108
TELEFUNKEN	0136, 0289, 0362, 0652, 0729	BEAUMARK	0267	ITT	0068, 0131, 0267	PALLADIUM	0064, 0068, 0099
TELEMEISTER	0347	BELL & HOWELL	0131	ITV	0064, 0305	PANASONIC	0062, 0252, 0253, 0643, 1062, 1589
TELETECH	0036	BLAUPUNKT	0253	IMPERIAL	0027	PATHE MARCONI	0068
TENSAI	0347	BRANDT	0347	INTERFUNK	0108	PENNEY	0062, 0064, 0069, 0267, 1062, 1264
TERA	0057	BRANDT ELECTRONIC	0068	JVC	0068, 0072, 0094	PENTAX	0069
THOMSON	0136, 0314, 0587, 0652, 1474	BROKSONIC	0211, 0375, 1506	JENSEN	0068	PERDIO	0027
		BUSH	0099, 0305, 0379	KEC	0064, 0305	PHILCO	0062
THORN	0064, 0131, 0388, 0539	CCE	0099, 0305	KLH	0099	PHILIPS	0062, 0108, 0645, 1108, 1208
THORN	0064, 0131, 0388, 0539	CGE	0027	KAISUI	0099	PHONOLA	0108
TOSHIBA	0087, 0181, 0183, 0535, 0645, 0677, 0859, 1283, 1383, 1683, 1731	CALIX	0064			PILOT	0064
		CANON	0062				
TRIUMPH	0543	CARVER	0108				
TUNTEX	0036, 0057, 0119	CIMLINE	0099				
		CINERAL	0305				
		CITIZEN	0064, 0305, 1305				
		COLT	0099				
		COMBITECH	0379				

VCR

PIONEER	0069, 0094, 0108	TELEFUNKEN	0068, 0347
POLK AUDIO	0108	TENOSAL	0099
PROFITRONIC	0267	TENSAI	0027
PROLINE	0027	THOMAS	0027
PROSCAN	0087, 1087	THOMSON	0068, 0087, 0094, 0347
PROTEC	0099	THORN	0068, 0131
PULSAR	0066	TIVO	0645, 0663
PYE	0108	TOSHIBA	0068, 0070, 0072, 0094, 0108, 0872
QUASAR	0062, 1062	TOTEVISION	0064, 0267
QUELLE	0108	UHER	0267
RCA	0062, 0069, 0087, 0267, 0834, 1062, 1087	UNITECH	0267
RADIOSHACK	0027	UNIVERSUM	0027, 0064, 0108, 0267
RADIOLA	0108	VECTOR	0072
RADIX	0064	VICTOR	0068, 0094
RANDEX	0064	VIDEO CONCEPTS	0072
REALISTIC	0027, 0062, 0064, 0074, 0075, 0131	VIDEOMAGIC	0064
REOC	0375	VIDEOSONIC	0267
REPLAYTV	0641, 0643	VILLAIN	0027
REX	0068	WARDS	0027, 0062, 0069, 0074, 0075, 0087, 0099, 0108, 0267
ROADSTAR	0064, 0099, 0267, 0305	WHITE WESTINGHOUSE	0099
RUNCO	0066	XR-1000	0027, 0062, 0099
SBR	0108	YAMAHA	0068
SEG	0267	YAMISHI	0099
SEI	0108	YOKAN	0099
STS	0069	YOKO	0267
SABA	0068, 0347	ZENITH	0027, 0060, 0066, 1506
SALORA	0070		
SAMPO	0064, 0075		
SAMSUNG	0072, 0267, 0459		
SANKY	0066, 0075		
SANSUI	0027, 0068, 0094, 1506		
SANYO	0074, 0131, 0267		
SAVILLE	0379		
SCHAUB LORENZ	0027, 0068, 0131		
SCHNEIDER	0027, 0099, 0108		
SCOTT	0070, 0072, 0211		
SEARS	0027, 0062, 0064, 0069, 0074, 0131, 1264		
SELECO	0068		
SEMP	0072		
SHARP	0075, 0834		
SHINTOM	0099, 0131		
SIEMENS	0064, 0108, 0131		
SILVA	0064		
SINGER	0072, 0099		
SINUDYNE	0108		
SONIC BLUE	0641, 0643		
SONTEC	0064		
SONY	0027, 0059, 0060, 0062, 0663, 1259		
SUNKAI	0375		
SUNSTAR	0027		
SUNTRONIC	0027		
SYLVANIA	0027, 0062, 0108, 0070, 1808		
SYMPHONIC	0027		
TMK	0267		
TANDY	0027, 0131		
TASHIKO	0027, 0064		
TATUNG	0027, 0068, 0072, 0094, 0108		
TEAC	0027, 0068, 0305, 0334, 0669		
TECHNICS	0062, 0253		
TECO	0062, 0064, 0068, 0075		
TEKNIKA	0027, 0062, 0064		
TELEAVIA	0068		



© 2005 YAMAHA CORPORATION All rights reserved.

YAMAHA ELECTRONICS CORPORATION, USA 6660 ORANGETHORPE AVE., BUENA PARK, CALIF. 90620, U.S.A.
YAMAHA CANADA MUSIC LTD. 135 MILNER AVE., SCARBOROUGH, ONTARIO M1S 3R1, CANADA
YAMAHA ELEKTRONIK EUROPA G.m.b.H. SIEMENSSTR. 22-34, 25462 RELLINGEN BEI HAMBURG, GERMANY
YAMAHA ELECTRONIQUE FRANCE S.A. RUE AMBROISE CROIZAT BP70 CROISSY-BEAUBOURG 77312 MARNE-LA-VALLEE CEDEX02, FRANCE
YAMAHA ELECTRONICS (UK) LTD. YAMAHA HOUSE, 200 RICKMANSWORTH ROAD WATFORD, HERTS WD18 7GQ, ENGLAND
YAMAHA SCANDINAVIA A.B. J A WETTERGRENS GATA 1, BOX 30053, 400 43 VÄSTRA FRÖLUNDA, SWEDEN
YAMAHA MUSIC AUSTRALIA PTY, LTD. 17-33 MARKET ST., SOUTH MELBOURNE, 3205 VIC., AUSTRALIA

YAMAHA CORPORATION
Printed in Malaysia © WF09590